

# FRANKLIN FRANCE

---

PRODUCT  
CATALOG



THE GLOBAL APPROACH  
TO LIGHTNING



# SUMMARY

---

<b>03</b>	<b>FRANKLIN FRANCE</b>
<b>08</b>	<b>PRACTICAL GUIDE</b>
<b>18</b>	<b>LIGHTNING PRODUCTS</b>
<b>19</b>	LIGHTNING RODS
<b>27</b>	LIGHTNING COUNTERS
<b>28</b>	MAST EXTENSIONS AND FIXINGS
<b>31</b>	MESHED CAGES
<b>32</b>	CONDUCTORS
<b>34</b>	CONDUCTOR FIXINGS
<b>39</b>	EARTHING SYSTEM
<b>44</b>	CONDUCTOR CONNECTIONS
<b>46</b>	<b>SURGE PRODUCTS</b>
<b>49</b>	MULTIPOLAR LV SURGE ARRESTERS TYPE 1+2 MODE C1
<b>50</b>	PMULTIPOLAR LV SURGE ARRESTERS TYPE 1+2 MODE C2
<b>51</b>	UNIPOLAIRES LV SURGE ARRESTERS TYPE 1+2+3
<b>52</b>	SURGE PROTECTORS N/PE UNIPOLAR
<b>53</b>	MULTIPOLAR LV SURGE ARRESTERS TYPE 1+2+3 MODE C2
<b>54</b>	SURGE ARRESTERS UNIPOLAIRES TYPE 2
<b>55</b>	MULTIPOLAR LV SURGE ARRESTERS TYPE 2 MODE C2
<b>56</b>	SINGLE-POLE LV SURGE PROTECTORS TYPE 2 (OR 3)
<b>57</b>	MULTIPOLAR LV SURGE PROTECTORS TYPE 2 (OR 3) MODE C2
<b>58</b>	SPECIFIC SURGE ARRESTER DISCONNECTORS
<b>59</b>	SPECIFIC SURGE ARRESTER DISCONNECTORS
<b>60</b>	<b>ASSOCIATED PRODUCTS</b>
<b>61</b>	STORM DETECTOR
<b>62</b>	GUYING KIT
<b>63</b>	PYLONS
<b>64</b>	AERIAL BEACONS



# FRANKLIN FRANCE

---

World leader in the manufacture of lightning protection systems, Franklin France is committed to always serving you better by exploiting the development resources of a large structure by combining the responsiveness and proximity of a company on a human scale. ISO 9001 certified, Franklin France is constantly evolving and draws its wealth from the quality of its teams and experts. Product quality and customer satisfaction are its priority.

Our global approach to lightning is available through:

- Listening and customer satisfaction-oriented service with national and international logistics and multilingual teams specializing in import-export.
- Mastering the lightning phenomenon with its research, engineering and development teams, and the support of the Lightning Innovation and Research Institute (LiRi) laboratory.
- Carrying out lightning risk analyzes (LRA) and technical studies (TS), with ProtecRisk software.
- Innovative products constantly at the cutting edge of technology including the Active 1D® Lightning Rods, Active 2D® (remote testable), and the 4D® protection unit.
- Installation, verification and maintenance.
- Communication through our website and social networks (Linkedin, Facebook).

Obtaining the Qualifoudre standard since 2005 demonstrates the quality of services in 5 areas: Manufacturing, Lightning Risk Analysis, Technical Study, Installation and Verification with qualified personnel from level I to IV.



# OUR HISTORY

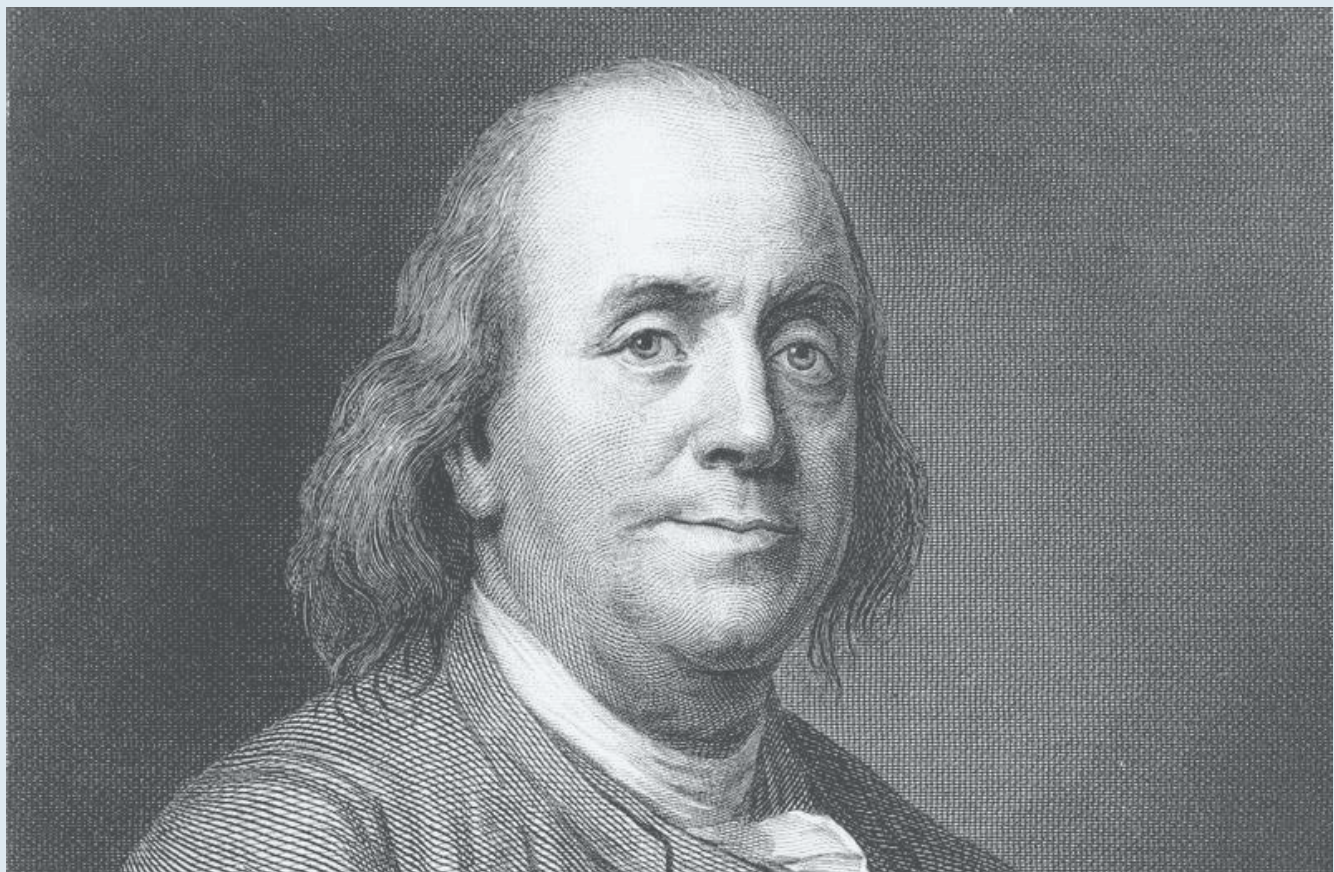

## WHY FRANKLIN FRANCE ?

The name Franklin France is not chosen at random, but rather in homage to Benjamin Franklin. At the time, when the natural phenomenon of lightning was still largely unexplored, it was with a clairvoyant vision that he designed a lightning rod consisting of a pointed metal pole connected to a conductor descending to the ground. The objective was to attract the lightning towards the mast and direct it safely to the ground, thus protecting the buildings from fires started by the lightning bolts. The name chosen for the company therefore reflects the qualities of Benjamin Franklin: a deep dedication to innovation and protection, fundamental values and missions that are an integral part of our company.

It is in this spirit that Franklin France was founded at the end of the 1980s by Michel Roubinet, an engineer by training. Under his leadership, we have refined our lightning protection services, guided by Franklin's visionary legacy. Since its creation, the company's main activity has been the design, production, marketing and installation of protection equipment against lightning and atmospheric surges.

What distinguishes Franklin France as a French manufacturer is its unique ability to meet all needs related to lightning: direct and indirect protection, up to storm detection.

# OUR VISION

People are at the heart of the company's overall development strategy. This allows us to build lasting, mutually beneficial relationships, both within our business and in our interactions with customers.



# OUR MISSION

1

We are committed to exceeding our customers' expectations by offering a service based on attentive listening and responding to their needs.

2

Our commitment to quality is evident in our premium products, all carefully designed to meet the highest standards.

3

Our products offer a comprehensive approach to lightning, combining technological innovation and expertise to ensure maximum safety.

5 SUBSIDIARIES

# WE ARE EVERYWHERE IN FRANCE

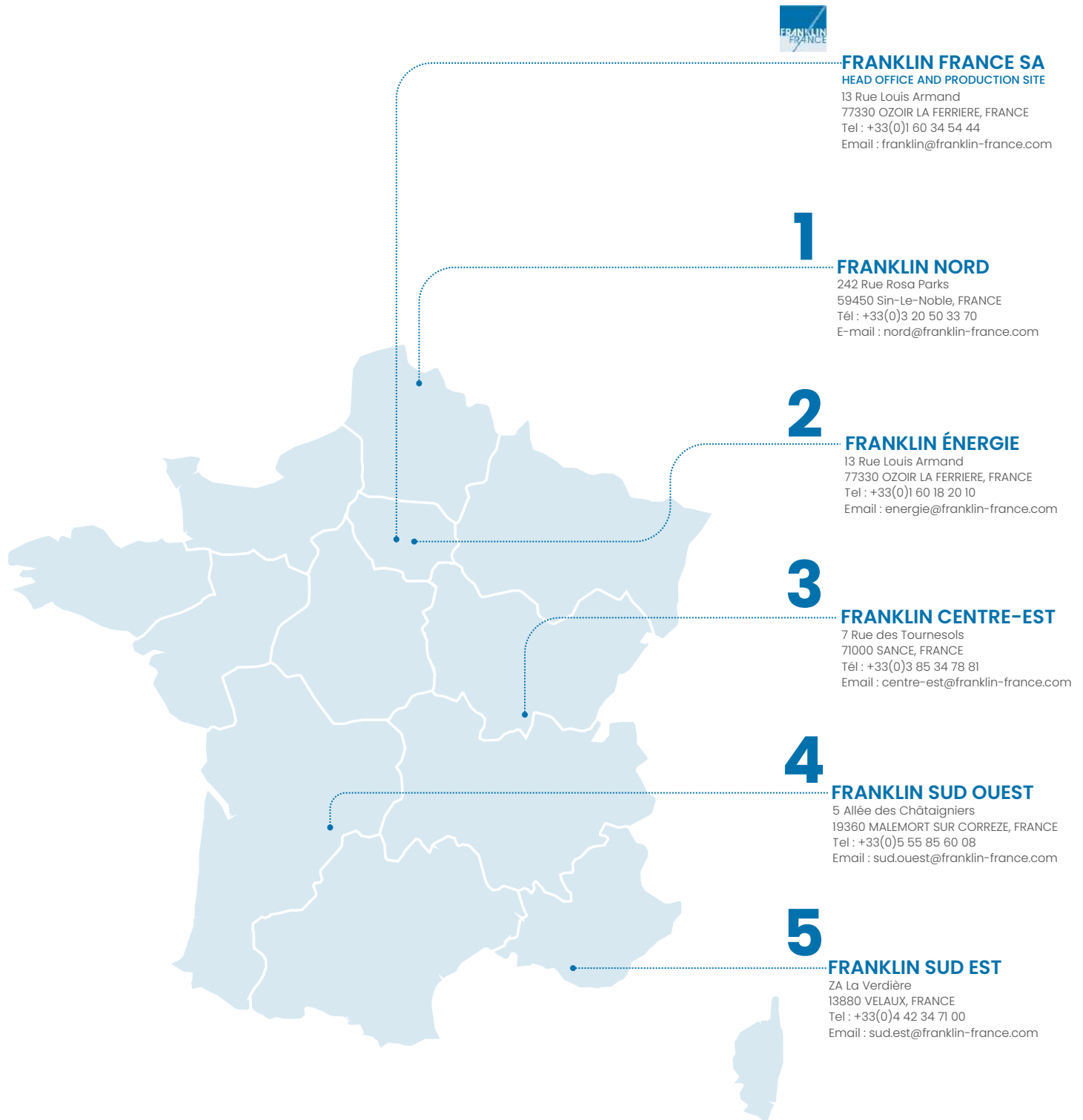

# FRANKLIN FRANCE

# AN INTERNATIONAL DIMENSION



**Distribution**  
in more than 80  
countries



**References**  
in all sectors of activity



**Export**  
represents 50% of turnover



**+ of 150 000 ESEs**  
sold worldwide



# PRACTICAL GUIDE



## THE GLOBAL APPROACH TO LIGHTNING

Protecting yourself against lightning does not consist of simply installing lightning rods. In fact, their installation only guarantees the protection of structures and individuals against the direct impacts of lightning. A significant part of the current generated by lightning and captured by a lightning rod is dissipated in the earth of the installation. However, indirect effects, such as transient surges, resulting from lightning strikes on or near a facility can be extremely critical to equipment.

Protection can only be effective and reliable when all phenomena are taken into account to protect against:

- The direct effects of lightning,
- Indirect effects such as earth rises, induced currents, etc.
- Grounding faults.

Protection can only be achieved as part of a global approach which assumes control of all stages, namely:

- Lightning risk analysis (LRA) determining the risk level from 1 to 4,
- The technical study (TS) making it possible to define the protection device appropriate to each situation and its method of installation,
- The implementation of protection devices in accordance with the standards in force until final acceptance of the installation,
- Maintenance of the lightning protection system.

## PREVENTION

Advanced detection of storms allows, with an anticipation period, to implement procedures and means of protection, likely to limit the importance of the destructive effects of storms with a view to reducing their impact and cost. economic.

## LIGHTNING RISK ANALYSIS, TECHNICAL STUDY, VERIFICATIONS

Drawing on its engineering and installation service, FRANKLIN FRANCE carries out on behalf of specifiers and its customers all the steps necessary for the smooth running of projects, from risk assessment to installation verification. :

- Lightning Risk Analysis according to the IEC / NF EN 62305-2 standard, the decree of February 28, 2022 in particular with the ProtecRisk software.
- Technical study according to standards: IEC / NF EN 62305-3 & 4, NFC 17-102, NFC 15 100, UTE-C guide 15 443...
- Initial and periodic checks according to technical studies and standards applicable to the different sites at the time of installation.

PROTECTION LEVEL	VISUAL INSPECTION (YEAR)	COMPLETE INSPECTION (YEAR)	COMPLETE INSPECTION OF CRITICAL SYSTEMS (YEAR)
1 and 2	1	2	1
3 and 4	2	4	1

## PROTECTION AGAINST LIGHTNING

Protection against lightning or "direct effects" consists of:

- Capture lightning by creating a preferred point of impact with a natural or specific capture device (lightning rod, mesh cage or stretched wire),
- Channel the lightning current by facilitating its passage by "earth descents",
- Flow the lightning current to the earth by ensuring its dispersion in the ground with a lightning conductor earth network.





## THE MESHED CAGE

Meshed cage protection consists of creating, on the surface of a building, a large mesh Faraday cage, connected to the ground with earth connections. Small rods (0.5 meters), called shock points, can be placed around the edges of roof meshes and on all exits (chimneys, aedicules, etc.).

The size of the mesh as well as the distance between two downspouts depend on the level of protection to be achieved as described in the IEC / NF EN 62305-3 standard.

PROTECTION LEVEL	FICTITIOUS SPHERE RADIUS R	MESH SIZE	DESCENT SPACE
I	20 m	5 x 5 m	10 m
II	30 m	10 x 10 m	10 m
III	45 m	15 x 15 m	15 m
IV	60 m	20 x 20 m	20 m

## THE TIGHT STRAND

This system consists of protecting a structure by avoiding coming into contact with it. This protection is often used in the case of storage of dangerous products (interior or exterior). This system is governed by the IEC / NF EN 62305-3 standard.



## PROTECTION ANGLES (IEC/NF EN 62305-3)

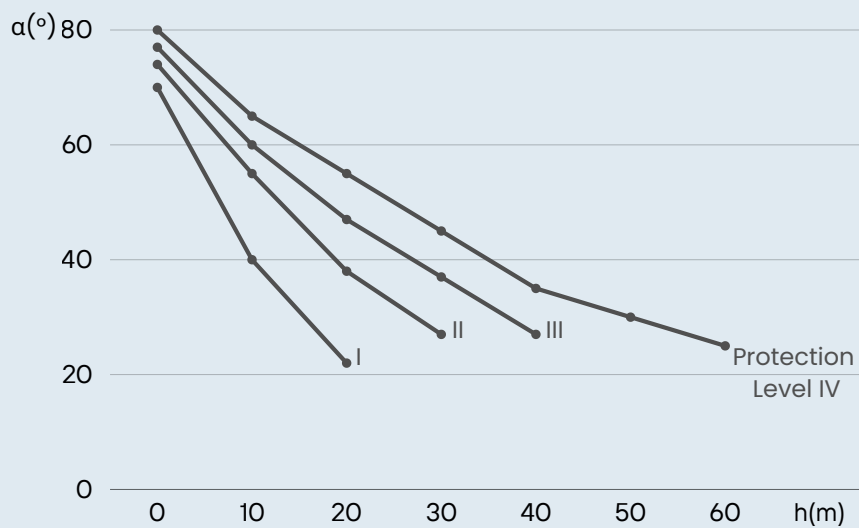

h: height of the capture device above the volume to be protected.

" $\alpha$ ": half angle at the top of the cone of revolution, defining the protection radius.

I, II, III, IV: protection levels defined by standard NF EN 62305-3.

### TO SIMPLE RODS

Also called Franklin type rod lightning rods, these installations consist of the construction, in the upper part of the structures to be protected, of tapered points connected to the earth by the most direct route. We can then determine a protection cone (described in the IEC / NF EN 62305-3 standard) which is a function of the height where it is located and the level of protection. Unlike the meshed cage, this protects the elements that are within its protection radius. This system is generally used on small buildings or on pylons.

### THE ESE

The principle of a Lightning Rod consists of equipping a simple rod with a device to reduce the value of the initiation times.

The ESE initiates the discharge earlier than a simple rod with an ignition advance  $\Delta t$ , it therefore has a better probability of capturing the descending tracer and channeling the lightning current. The radius of protection offered by this type of lightning rod is therefore much greater than a simple rod. Its implementation is governed by standard NFC 17-102.

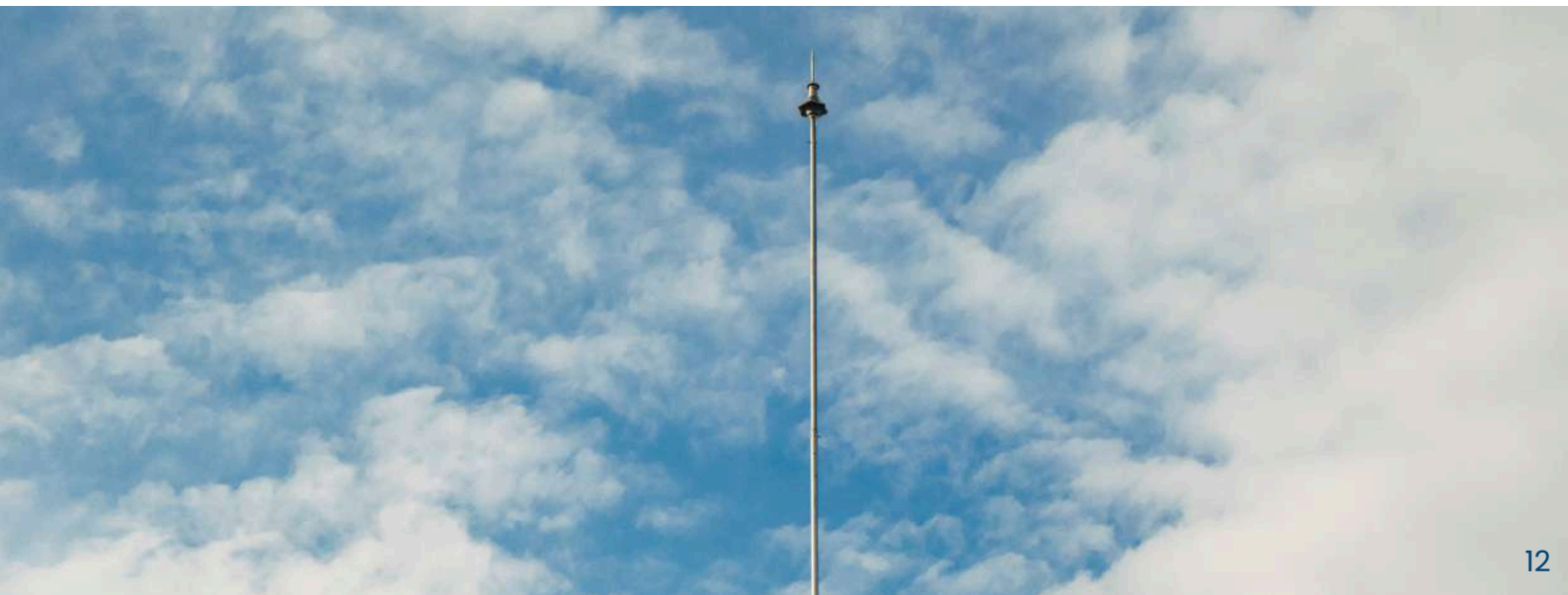



- 1 Active Lightning Rod 1D+\*/2D\*
- 2 Fixing the mast and driver
- 3 Horizontal conductor mounting
- 4 Avoid right angles
- 5 Conductor attachment: 3 per meter
- 6 Impact controller
- 7 Cut-off terminal
- 8 Inspection manhole
- 9 Lightning earth connection
- 10 Second Lightning Descent
- 11 Power grid protection
- 12 Protection of data transmission lines
- 13 Coaxial cable protection
- 14 Active 2D\* remote tester

## INSTALLATION OF THE LIGHTNING ROD AND THE DOWNSPOUT

The principles of lightning installation are given in the two main standards: IEC / NF EN 62305-3 & 4 for the protection of structures against lightning and NF C 17-102 for the protection by ESE of structures and open areas:

- Any lightning rod must preferably be placed on the highest point, possibly enhanced by one (or more) extension pole(s), extending at least two meters above all the roof elements to be protected. The number of fixing brackets will depend on the height of the lightning rod and the wind region.
- Each lightning rod alone must be equipped with two down conductors, preferably made of tinned copper tape complying with the IEC / NF EN 62561-4 standard, fixed according to the applicable standard. Each down conductor will be equipped with its accessories (cutting terminal, protective sheath, nameplate).



## REMOVAL AND HANDLING OF RADIOACTIVE LIGHTNING RODS

Franklin France carries out the removal and handling of radioactive lightning rods on all types of buildings and throughout the metropolis (Authorization from the ASN Nuclear Safety Authority n°F420002).

While awaiting final disposal, the radioactive lightning rods are stored in our approved storage facilities located in Ozoir-la-Ferrière (77), Malemort sur Corrèze (19), Velaux (13).

## PROTECTION AGAINST OVERVOLTAGE

Protection against transient overvoltages or "indirect effects" consists of:

- Prevent lightning current from reaching equipment by diverting it to earth with a lightning arrester or surge protector,
- Maintain a residual voltage compatible with the protected equipment,
- Channel and drain current to ground.



## EARTH CONNECTIONS AND EQUIPOTENTIALITY

An installation can only be effectively protected if:

- The flow of current to earth and its dispersion in the ground are guaranteed by creating a low impedance earth connection (as conductive as possible),
- All the metal masses of the building are equipotentially connected to the building's electrical earth or "excavation base",
- The "equipotentiality" of the building earth and the lightning conductor earth is achieved.
- The resistivity of the earth does not exceed a value of 10 ohms.

# EARTH CONNECTIONS

The lightning ground network can be constituted differently depending on the standards used:

## 1) ESE (NFC 17-102) :

- Creation of type A earth connections with a value less than or equal to  $10 \Omega$  or failing that made up of a measurement of electrodes given by the standard in force.
- Creation of a type B earth network (loop at the bottom of the excavation on the periphery of the building to be protected, supplemented by simplified type A earth connections at the foot of each down conductor).

## 2) Meshed cage, tight strand, simple rod (IEC / NF EN 62305-3):

- Creation of type A earth connections with a value less than or equal to  $10 \Omega$  or failing that made up of a measurement of electrodes according to the level of protection and the resistivity of the ground given in figure 2 of the standard.
- Creation of a type B earth network (loop at the bottom of the excavation on the periphery of the building to be protected, supplemented by type A earth connections, all dimensioned according to figure 2 of the standard).

The earth connection value must be measured by conventional means at the earth connection isolated from any other conductive element. Below, example of measurement using the 3 stakes method:

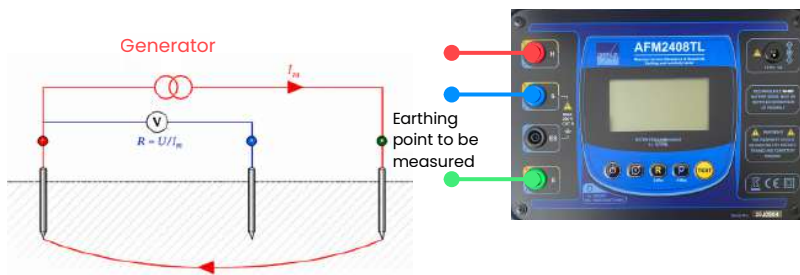

Measuring the resistivity of the ground allows you to size type A and/or type B earth networks according to the IEC / NF EN 62305-3 standard.

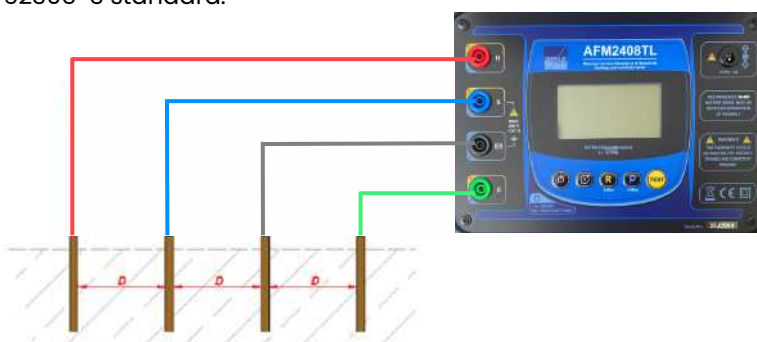



## INSTALLATION OF LIGHTNING EARTH CONNECTIONS

The earth connection of the lightning conductor must be connected equipotentially, either directly to the earth circuit at the bottom of the accessible excavations, or to a hold brought back to the foot of the descent, using a conductor conforming to the IEC / NF EN 62561-2 standard. It will be made disconnectable from the site's ground network via an inspection pit or an equipotentiality strip. There are several type A earth connections, which mainly depend on the environment in which they are going to be installed:

- 1) **By triangulated stakes:** this is one of the two earth connections described in the standard, and which uses the least conductor.
- 2) **Crow's feet system:** this is the second earth connection described in the standard. It occupies a larger surface area since the 3 horizontal conductors are each 8 m.
- 3) **Improved crow's feet system:** it often allows soils of different types to be found to reduce resistance by completing each strand with a vertical earth electrode.
- 4) **By aligned stakes:** this system is used in conditions where earthmoving areas are restricted.
- 5) **Simplified earth connection (NFC 17-102):** it consists of the installation of 4 meters of horizontal electrodes or 2 meters vertical in addition to the type B earth network.

1

Prise de terre paratonnerre  
Système patte d'oie améliorée

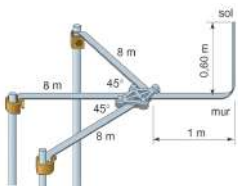

2

Prise de terre paratonnerre  
Système patte d'oie

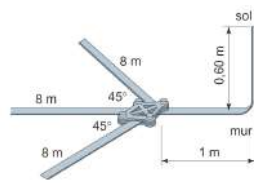

3

Prise de terre paratonnerre  
Par piquets triangulés

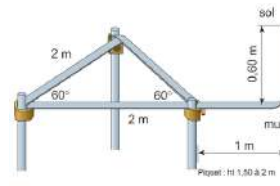

4

Prise de terre paratonnerre  
Par piquets alignés

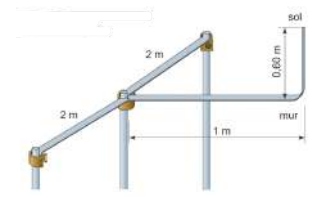

# TRAINING

---

In partnership with the LiRi laboratory, Franklin France makes the field of lightning accessible to everyone by offering a complete range of courses adapted to your needs for the design and implementation of lightning protection systems. Each year, numerous training sessions are organized for both our national and international clients. We also offer training programs dedicated to company employees and control bodies, aimed at strengthening their skills and ensuring optimal implementation of their responsibilities. Furthermore, interventions in institutions are proposed to raise awareness of the risk linked to lightning from an early age. Training is also provided to obtain the qualifoudre NI and N2 diploma.





LIGHTNING PRODUCTS

## LIGHTNING PRODUCTS

Rp (m)	ACTIVE 1D+				ACTIVE 1D+				ACTIVE 2D®/ACTIVE 4D®				ACTIVE 1D+				ACTIVE 1D+/2D®/4D®			
	T = 12 µs				T = 25 µs				T = 30 µs				T = 45 µs				T = 60 µs			
h (m)	I	II	III	IV	I	II	III	IV	I	II	III	IV	I	II	III	IV	I	II	III	IV
2	11	13	16	19	17	20	23	26	19	22	25	28	25	28	32	36	31	35	39	43
4	23	27	32	37	34	39	46	52	38	44	51	57	51	57	65	72	63	69	78	85
5	28	34	41	46	42	49	57	65	48	55	63	71	63	71	81	89	79	86	97	107
6	29	34	42	48	43	49	58	66	48	55	64	72	63	71	81	90	79	87	97	107
8	30	36	43	50	43	50	59	67	49	56	65	73	64	72	82	91	79	87	98	108
10	30	37	45	52	44	51	61	69	49	57	66	75	64	72	83	92	79	88	99	109
20	32	41	51	60	45	54	65	75	50	59	71	81	65	74	86	97	80	89	102	113
30	30	42	55	65	44	55	68	80	49	60	73	85	64	75	89	101	79	90	104	116
60	-	30	55	72	21	46	68	85	30	52	73	90	52	69	89	105	69	85	104	120

### PROTECTION BY LIGHTNING ROD WITH STARTING DEVICE

The principle of a Earlu Streamer Emission Lightning Rod (ESE) consists of improving the performance of a single lightning rod (SLR) by a device to reduce the initiation time. The PDA triggers the discharge earlier than a SLR with a priming advance  $\Delta T$ . It therefore has a better probability of capturing the descending tracer and channeling the lightning current. Thus, the protection zone offered by this type of lightning rod is much greater than a simple rod lightning rod.

The protection zone of a ESE is defined by the application of the electro-geometric model of the fictitious sphere taking into account the priming advance of the ESE determined in the test laboratory in accordance with the requirements of the NF C standard. 17-102. Practically, the NF C 17-102 standard allows you to calculate the value of the protection radius of the PDA at a given height.

The protection radius of a ESE  $Pr$  is linked to its height ( $h$ ) in relation to the surface to be protected, to its efficiency  $\Delta T$  and to the level of protection determined by the lightning risk analysis.

The protection radius ( $Pr$ ) is calculated using the following formulas:

$$R_p(h) = \sqrt{2rh - h^2 + \Delta(2r + \Delta)} \quad \text{pour } h \geq 5 \text{ m} \\ \text{et}$$

$$R_p = h \times R_p(5) / 5 \quad \text{pour } 2 \text{ m} \leq h \leq 5 \text{ m}$$

Or :

- $Pr(m)$  corresponds to the protection radius at a given height  $h$ ;
- $h(m)$  corresponds to the height of the end of the ESE on the horizontal plane to the farthest point from the object to be protected;
- $r(m)$  depends on the level of lightning protection
  - 20 m for protection level I;
  - 30 m for protection level II;
  - 45 m for protection level III;
  - 60 m for protection level IV;
- $\Delta (m)$   $\Delta = \Delta T \times 10^6$ ;  $\Delta T (\mu s)$  being the efficiency of the ESE;

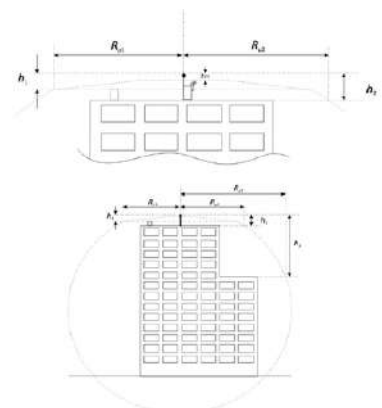

# ACTIVE ID+ : ELECTRONIC SYSTEM WITH PRIMING DEVICE

## PRINCIPLE AND OPERATION

The new Active ID+ lightning rod is designed for maximum safety during storms. Its modern design, lightweight design, and new advanced performance tests make it the ideal solution for protecting your infrastructure. Its nickel-plated copper tip offers better laboratory results and amplifies its triggering potential thanks to its shape. Designed to withstand extreme weather conditions, it offers great durability and excellent corrosion resistance. In addition, this device requires no power source or specific maintenance, thus ensuring high reliability of the Active ID+.

The advance of the Active ID+ lightning rod is obtained by the polarization (positive or negative) of its internal device connected to its tip subjected to the storm electric field. As the precursor phenomena of the lightning strike approach, this internal oscillating device is powered by the natural corona effect and brings the tip of the tip to a high voltage potential ( $> 20\text{kV}$ ) in synchronization with the precursor phenomena of the lightning strike. The resulting strong amplification of the ionization at the tip of the lightning rod triggers the early emission of an ascending tracer at the right time for connection with the descending tracer of the cloud and the capture of the lightning strike safely.

Active ID+ technology offers guarantees of optimal performance and repeatability. The requirements and test procedures of Annex C of NF C 17-102: 2011 were strictly observed: complete sequence of consecutive tests on the same lightning conductor. Laboratory efficiency tests revealed a very low dispersion of the lightning rod results (standard deviation) demonstrating optimal repeatability of its starting device. Insulation against extreme weather conditions (heavy rain) has been reinforced, providing reliability of the protection zone. Franklin France exceeds regulatory requirements with major certifications. All tests and trials carried out on the Active ID+ were inspected by Bureau Veritas, which validated and certified its effectiveness.

MODEL	TIME	HEIGHT	REFERENCE	COUNTER	WEIGHT
ACTIVE ID+12	12 $\mu\text{s}$	0,490 m	AFB2012ID	not included	2,13 kg
ACTIVE ID+12	12 $\mu\text{s}$	0,490 m	AFB2712ID	included	2,63 kg
ACTIVE ID+25	25 $\mu\text{s}$	0,490 m	AFB2025ID	not included	2,13 kg
ACTIVE ID+25	25 $\mu\text{s}$	0,490 m	AFB2725ID	included	2,63 kg
ACTIVE ID+45	45 $\mu\text{s}$	0,490 m	AFB2045ID	not included	2,13 kg
ACTIVE ID+45	45 $\mu\text{s}$	0,490 m	AFB2745ID	included	2,63 kg
ACTIVE ID+60	60 $\mu\text{s}$	0,490 m	AFB2060ID	not included	2,13 kg
ACTIVE ID+60	60 $\mu\text{s}$	0,490 m	AFB2760ID	included	2,63 kg

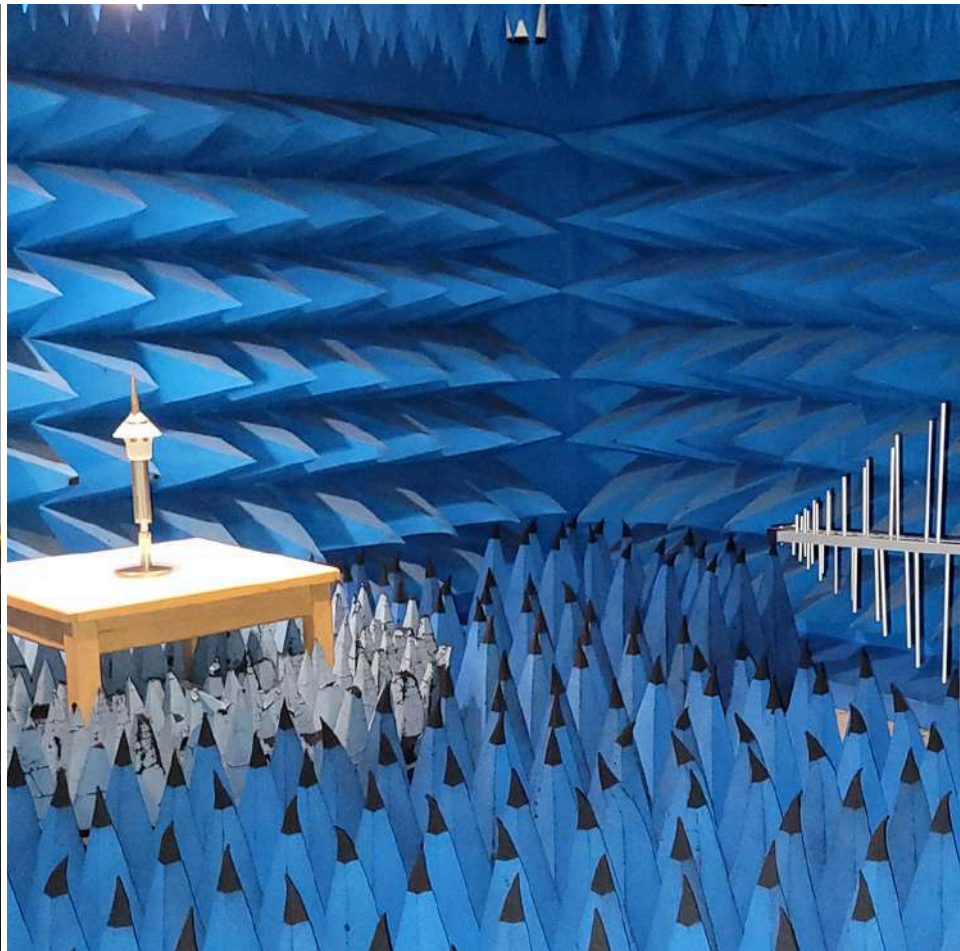

# ACTIVE 2D®: ELECTRONIC SYSTEM WITH DOUBLE PRIMING DEVICE

## PRINCIPLE AND OPERATION

The operating principle of the Active 2D® lightning rod consists, not only, of initiating the ascending tracer, but above all, of providing it with the energy necessary to ensure its propagation to the junction with the descending tracer.

- A first device, called " **PULSE DEVICE**", stores the electrostatic energy present in the atmosphere when a storm cloud approaches and triggers the initiation of the ascending discharge at the appropriate time.
- A second device, called "**BOOSTER**", allows solar energy to be collected and stored in power capacitors. The Active 2D® lightning rod is thus permanently pre-charged with significant energy which allows it to support the propagation of the ascending tracer.

When storm activity approaches, an integrated sensor measuring the value of the ambient electric field triggers the impulse device like most lightning rods with a standard Early Streamer Emission device. This causes an almost instantaneous reversal of the polarity of the head of the lightning rod, leading to a sudden amplification of the electric field on its tip. The innovation comes from the use of a second integrated sensor which measures the intensity of the current of the electrical discharge which forms on the tip of the lightning rod. When the descending tracer enters the protection zone of the lightning rod, the measured current increases sharply. As soon as this current is greater than a characteristic threshold, the power capacitors discharge and release the energy necessary for the propagation of the tracer. In this last device, the head of the lightning rod plays the role of capture organ. It is, therefore, electrically isolated from earth.

The Active 2D® lightning rod was tested at the Bazet Test Center (CEB) in accordance with the NFC 17-102 standard and is the subject of an on-site testing campaign. The ignition advance of the Active 2D® lightning rod was determined in relation to a reference point obtained by short-circuiting the double device of this lightning rod.

The Active 2D® lightning rod can be tested on site using its remote tester box and/or with the wired tester (AFV0050TT, AFV 0101TT, AFV0200TT). Test reports are available on request.

MODEL	TIME	HEIGHT	REFERENCE	COUNTER	TESTER	WEIGHT	DIMENSIONS
ACTIVE 2D®30	30 µs	1 m	AFB10302D	not included	not included	6.9 kg	320x320x500 mm
ACTIVE 2D®60	60 µs	1 m	AFB10602D	not included	not included	6.9 kg	320x320x500 mm
ACTIVE 2D®30	30 µs	1 m	AFB17302D	included	not included	6.9 kg	320x320x500 mm
ACTIVE 2D®60	60 µs	1 m	AFB17602D	included	not included	6.9 kg	320x320x500 mm
ACTIVE 2D®30	30 µs	1 m	AFB18302D	not included	included	6.9 kg	320x320x500 mm
ACTIVE 2D®60	60 µs	1 m	AFB18602D	not included	included	6.9 kg	320x320x500 mm



## WIRED TESTER FOR ACTIVE 1D+/2D®

Active 1D+® and Active 2D® lightning rods can be tested on site with the AFV0050TT wired test box (compliant with standard NFC 17-102). Simple and quick, this test can be carried out either by removing the lightning rod or by using the telescopic pole (AFV0087PT), which allows it to be reached up to 8 meters. This tester is powered by a battery (provided). The indicator light display instantly indicates the result obtained (positive or negative).

## REMOTE TESTER FOR ACTIVE 2D®

The Active 2D® lightning rod can be tested on site with its remote tester, without requiring dismantling (compliant with standard NFC 17-102). The tests are carried out safely from the ground, thanks to radio wave communication. The Active 2D® and its tester are equipped with a transmitter/receiver for two-way communications. The tester runs on a supplied battery and instantly displays results (positive or negative) using LEDs.

REFERENCES	DESIGNATION	WEIGHT	DIMENSIONS
AFV0050TT	Active 1D+® and Active 2D® wired tester	0,325 kg	80 x 200 x 40 mm
AFV0087PT	Active 1D+® and Active 2D® telescopic test pole	3,6 kg	1850 x Ømax 100 mm
AFV0101TT	Active 2D® Remote Tester	0,18 kg	65 x 130 x 25 mm



AFV0050TT



AFV0087PT



AFV0101TT

## MULTITESTER FOR ACTIVE 2D®

The Active 2D® lightning rod multitester allows you to check several lightning rods on the same site or on different sites.

The Active 2D® Multitester pack includes:

- A laptop for greater user comfort,
- The LMS MULTI 2D software (Lightning Monitoring System MULTI 2D) pre-installed in the factory,
- An Activ'control (communication box between the lightning rod and the software to collect information),
- The different connectors (RJ45 connector => USB, power supply),
- Programming of Active 2D® serial numbers (up to 5 factory serial numbers included).



# ACTIVE 4D® CENTRALE DE PROTECTION

## PRINCIPLE AND OPERATION

INNOVATION

The innovation of the Active 4D® central unit is to offer a complete lightning protection system, permanently connected with users.

- The Lightning Rod part uses the latest technologies for its excitation advance.
- The Detection part uses the patented system with a sensor (electrostatic and electromagnetic) to inform of the arrival of a storm.
- The Counter part informs in real time of any impact on the Active 4D® by giving all the characteristics and currents.
- The LMS software makes it possible to group together, in real time, all the information related to lightning phenomena on the site.

Thanks to the connected system, if the user wishes, it is possible to have access to their data anywhere in the world.

LIGHTNING ROD

The operating principle of the lightning rod part of the Active 4D® consists not only of initiating the ascending tracer, but above all, of providing it with the energy necessary to ensure its propagation to the junction with the descending tracer. The Active 4D® lightning rod system is equivalent to the Active 2D® lightning rod, having 2 devices: "impulse" and "booster".

The operating system can be continuously tested, either using a remote radio tester or electronically using the Activ'Control® box and the LMS (Lightning Monitoring System) software. 2 priming advances are offered by this product depending on the models: 30 and 60 µs. The system has been tested in accordance with the NFC 17-102 standard of September 2011 in an independent laboratory.

COUNTER

Active 4D® allows lightning strikes to be counted autonomously on the installation. The innovation comes from the integration of the counting system directly within this plant. This lightning strike counter allows you to time stamp and store the various impact information captured by the control unit (number of impacts, day/time of each impact, the value, form and energy of the lightning current ).

This data is then transferred to the Activ'Control® by radio. The operator, thanks to the LMS software, can permanently access the various data and visualize the lightning current curves. This device complies with the decree of July 19, 2011 and standard NF EN 62561-6.

DETECTOR

Active 4D® allows you to predict the arrival of a storm. Detection is done using an integrated sensor which precisely measures the value of the electromagnetic field. As soon as the recorded value indicates an imminent risk of lightning, the Active 4D®, thanks to its dry contact on the Activ'Control® box, takes the initiative of sending audible (siren, etc.) and/or visual alerts (beacon, etc.).

The LMS (Lightning Monitoring System) software, permanently connected to Activ'Control®, allows you to visualize the evolution of the risk and configure the detection thresholds. The great innovation of the system (patented) was to integrate prevention with protection against lightning.

MODEL	TIME	HEIGHT	REFERENCES	ACTIV'CONTROL (AFV2000TT)
ACTIVE 4D®60	60 µs	1 m	AFB18604D	included
ACTIVE 4D®60	60 µs	1 m	AFB10604D	not included

## “FRANKLIN TYPE” SINGLE ROD LIGHTNING RODS

These lightning rods offer a protection radius of between 5.5m and 31.10m depending on the height and level of protection (protection angles can be provided on request). These lightning rods are designed to withstand wind speeds of up to 160 km/h without guying. They can be fixed using all of the mounting brackets from the Franklin France range as well as the 2 tripod models. The Franklin France lightning rods are delivered with an AFJ3100SE collar.

REFERENCES	DESIGNATION	NATURE	HEIGHT	DIAMETER	WEIGHT
AFA2011PF	Lightning rod Franklin France	Stainless steel	2.30 m	42 mm	6.2 kg
AFA4011PF	Lightning rod Franklin France	Stainless steel	4.30 m	42 mm	14.7 kg
AFA6011PF	Lightning rod Franklin France	Stainless steel	6.30 m	42 mm	23.2 kg
AFE1130PC	Threaded sensor tip	Stainless steel	30 cm	M20 (male)	0,64 kg



## ELECTROMECHANICAL AND DIGITAL COUNTERS

Impact count or lightning counters are intended to detect and count lightning strikes received by structures equipped with lightning rods. Compulsory counter for classified sites, recommended for assessments by Insurance Companies.

The AFV1007CF counter is completely autonomous and does not require an external power supply.

The AFV0909CF time stamp counter indicates the date and time of the current shocks passing through the down conductor. The battery used is included (3.6V Lithium battery). No readings are lost when replacing batteries. Even if the batteries wear out and there is no display, measurements can be acquired normally.

REFERENCES	AFV0920CF	AFV1007CF	AFV0909CF
Designation	Digital counter	Electromechanical counter	Time-stamped digital counter
Display	00 > 999	00 > 999999	00 > 999
Detection limit	1 kA - 8/20 (wave)	2 kA - 10/350 (wave)	1 kA - 8/20 (wave)
Maximum discharge current detected	100 kA - 10/350 µs (wave)	100 kA - 10/350 µs (wave)	100 kA - 10/350 µs (wave)
Input and output conductors	Ø8 mm (50mm <sup>2</sup> ) / strip 27x2 mm to 30x3 mm	Ø 8 to 10mm and 30x2 ribbon and 30x3 mm	Ø 8 mm / feuillard 30x2 mm
Operating temperature	-	-10°C/+ 60°C	- 30 °C / + 80 °C
Protection sign	IP66/67	IP65	IP67
Dimensions	100 x 100 x 75 mm	150 x 60 x 50 mm	100x 100 x 75 mm
Weight	600 g	530 g	560 g



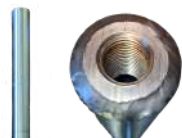

AFC1035MR  
AFC1242MR

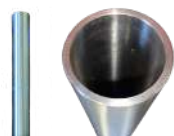

AFC1442MR  
AFC2242MR



AFD5001CE



AFD1411EB

## EXTENSION MASTS FOR LIGHTNING RODS

Franklin France extension masts are assembled by overlap and pressure screws for galvanized steel tubes, and by fitting for stainless steel tubes. Extremely robust, up to 3 masts can be combined without guy wires for wind speeds reaching 160 km/h under extreme conditions.

REFERENCES	DESIGNATION	NATURE	HEIGHT	DIAMETER	ELEMENT
AFC1035MR	Mast n°1 self-extending tapped M20 1D+ (with fitting AFB000IMG for 2D/4D)	Galvanized steel (sold as a kit)	2 m	35 mm	3,25 kg
AFC2042MR	Mast n°2 self-extending 1D+/2D/4D		2 m	42 mm	5 kg
AFC3050MR	Mast n°3 self-extending 1D+/2D/4D		2 m	50 mm	4,7 kg
AFC3350MR	Mast n°4 self-extending 1D+/2D/4D		3 m	50 mm	7,3 kg
AFC1242MR	Mast n°1 self-extending tapped M20 1D+	Stainless steel	2 m	42 mm	6,2 kg
AFC2242MR	Mast n°1 self-extending by fitting 2D/4D				8,2 kg
AFC1442MR	Set of self-extending masts 1D+	Stainless steel	4 m	42 mm	14,7 kg
AFC2442MR	Set of self-extending masts 2D/4D				16,7 kg
AFC1642MR	Set of self-extending masts 1D+	Stainless steel	6 m	42 mm	23,2 kg
AFC2642MR	Set of self-extending masts 2D/4D				25,2 kg
AFB000IMG	Threaded connection for 2D/4D	Stainless steel	-	-	400 g

## WATER DISCHARGE CONES

Their base, in reinforced aluminum alloy, forming the sole, allows them to adapt to different shapes of structures while ensuring waterproofing.

REFERENCES	DESIGNATION	NATURE	OBSERVATION	MAST DIAMETER	WEIGHT
AFD5001CE	Water discharge cone	EPDM aluminium	6 > 70	114 x 114 x 55 mm	0,070 kg
AFD5002CE	Water discharge cone	EPDM aluminium	6 > 146	203 x 203 x 85 mm	0,180 kg

## THREADED BASE

Fixing only ESEs and lightning rods with Franklin rods (excluding extension poles) on pylons and metal frames.

REFERENCE	DESIGNATION	NATURE	DRILLING DIAMETER	OBSERVATION	WEIGHT
AFD1411EB	Threaded base	Dichromated steel	M 16	Pierced poles	0,88 kg



AFD3200FS

## TRIPODS

Made of galvanized steel, they can accommodate all lightning rods as well as their mast's support with a maximum diameter of Ø 50 mm. The type of tripod as well as the number of slabs will be defined according to the configuration of the building to be protected as well as the wind region.

REFERENCES	DESIGNATION	HEIGHT	FIXATION PIED	CENTER DISTANCE	WEIGHT
AFD3200FS	Universal tripod	800 mm	M 10 max.	385 mm	6 kg
AFD3301FS	Telescopic tripod	600 > 2170 mm	M 10 max.	2238 > 3944	30 kg
AFH8046DA	Ballast slab	110 mm L 425 x l 330 mm	-	-	25 kg



AFD3301FS



AFH8046DA

AFD3301FS - NUMBER OF TILES PER FOOT				
CONFIGURATION	LIGHTNING ROD	LIGHTNING ROD + 1 MAST	LIGHTNING ROD + 2 MASTS	LIGHTNING ROD + 3 MASTS
1	1	1	1	2
2	1	1	1	2
3	1	1	2	3
4	1	1	2	3
5	1	1	3	5



AFZ2012PS

## STRAPPING

Straps are generally used for fixing lightning rods and their mast's support to chimneys, concrete masts, etc.

REFERENCES	DESIGNATION	NATURE	CLAMPING DIAMETER	OBSERVATION	WEIGHT
AFZ2012PS	Strapping tab	Dichromate zinc plated steel	25 > 60 mm	For lightning rods or masts	0,9 kg
AFD2011PS	Strapping 40 mm	Galvanized steel	-	Roll 5 m	1 kg



AFD2011PS

## MOUNTING BRACKETS

Fixing brackets for the installation of lightning rods alone or equipped with extension masts (2 brackets if lightning rod alone or equipped with an extension mast, 3 brackets if 2 or 3 extension masts). Recommended spacing between legs: 40cm.



AFZ0414PD



AFZ0513SL



AFZ0417FC



AFZ2008PS



AFZ0420PD

REFERENCES	DESIGNATION	NATURE	CLAMPING DIAMETER	INTEREST	WEIGHT
AFZ0414PD	"Offset" leg 220 mm	Galvanized steel	30 > 50 mm	Fixing by bolt, bolting, strapping...	1,44 kg
AFZ0514PD	"Offset" leg 310 mm	Galvanized steel	30 > 50 mm	Fixing by bolt, bolting, strapping...	1,68 kg
AFZ0614PD	"Offset" leg 220 mm	Stainless steel	30 > 50 mm	Fixing by bolt, bolting, strapping...	1,37 kg
AFZ0815PD	"Offset" leg 500 mm	Galvanized steel	30 > 50 mm	Fixing by bolt, bolting, strapping...	6,77 kg
AFZ0513SL	SL Paw	Galvanized steel	30 > 114 mm	Offset fixing of pylons, tub. vertical, metal frames...	2,27 kg
AFZ0417FC	X-shaped attachment	Galvanized steel	30 > 50 mm	Offset fixing of pylons, tub. vertical, metal frames...	1,48 kg
AFD1270PB	Platinum cladding	Aluminium	-	Fixing by rivet or screw	1,03 kg
AFZ2802FU	Fixing tab. universal	Galvanized steel	33 > 49 mm	Fixing by dowels, strapping...	1,08 kg
AFZ2008PS	Side sealing bracket 400 mm	Galvanized steel	33 > 50 mm	-	1,46 kg
AFZ0420PD	Fixing tab. cladding crossing	Galvanized steel	33 > 49 mm	Fixing by dowels or bolting...	1,30 kg



AFFI130PC

## SENSOR TIPS

Their base has a thread or tapping for their fixing by bolt, dowel, bolting, on all materials.

REFERENCES	DESIGNATION	NATURE	HEIGHT	FIXING DIAMETER	WEIGHT
AFFI130PC	Threaded sensor tip	Stainless steel	0,3 m	M 20 (male)	0,64 kg
AFFI050PC	Tapped sensor tip	Stainless steel	0,5 m	M 10 (female)	1 kg

## ATTACHING THE SENSOR TIPS

Threaded rods, support lag screws, expanding studs are delivered with sealing collar.

REFERENCES	DESIGNATION	NATURE	LENGTH	FIXATION	DRILLING DIAMETER	WEIGHT
AFF2025PC	Threaded shaft	Galvanized steel	100 mm	M 10 mm	-	80 g
AFF2026PC	Support tire-fond	Galvanized steel	140 mm	M 10 mm	-	65 g
AFF2030PC	Expansive Stud	Dichromate steel	85 mm	M 10 mm	12 x 60 mm	45 g
AFF0836PC	Square support	Tin-plated brass	50/50 x 30 x 5 mm	M 10 mm	-	120 g
AFF0834PC	Tip plate support	White zinc plated steel	90 x 90 mm	M 10 mm	-	246 g
AFF0835PC	Tip plate support	White zinc plated steel	65 x 65 mm	M 10 mm	-	76 g



AFF0836PC



AFF0835PC

## "TIP SUPPORT" BASES

The tip support crossing base acts as a connection and fixing for the sensor tips.

REFERENCE	DESIGNATION	NATURE	HEIGHT	DIAMETER	WEIGHT
AFF0503PC	Embase « support pointe »	Cupro aluminum. tinned	53 x 53 x 14 mm	M 10	220 g



AFF0503PC

## FLAT CONDUCTORS

Conductors for the flow of lightning current and/or equipotential connections (NF EN 62561-2).



AFG0310CP



AFG0302CP



AFG4303CP



AFG6303CP



AFG1012CP

REFERENCES	DESIGNATION	NATURE	DIMENSION	SECTION	WEIGHT
AFG0253CP	Flat conductor (per 50 m)	Tinned copper	25 x 3 mm	75 mm <sup>2</sup>	660 g/m
AFG0254CP	Flat conductor (per 50 m)	Bare copper	25 x 3 mm	75 mm <sup>2</sup>	660 g/m
AFG0310CP	Flat conductor (per 50 m)	Bare copper	27 x 2 mm	> 50 mm <sup>2</sup>	480 g/m
AFG0302CP	Flat conductor (per 50/80 m)	Tinned copper	27 x 2 mm	> 50 mm <sup>2</sup>	480 g/m
AFG0320CP	Flat conductor (per 50/80 m)	Tinned copper	30 x 2 mm	> 50 mm <sup>2</sup>	534 g/m
AFG4303CP	Flat conductor	Aluminium	30 x 3 mm	90 mm <sup>2</sup>	240 g/m
AFG2503CP	Ribbon 25/3	Aluminium	25 x 3 mm	75 mm <sup>2</sup>	208 g/m
AFG6303CP	Flat conductor under PVC	Bare copper	25 x 3 mm	> 50 mm <sup>2</sup>	250 g/m
AFG1012CP	Stainless steel ribbon. 30/2 (per 50 m)	Stainless steel	30 x 2 mm	> 50 mm <sup>2</sup>	480 g/m

## ROUND CONDUCTORS

Conductors for the flow of lightning current and/or equipotential connections (NF EN 62561-2).



AFG0028CR

REFERENCES	DESIGNATION	NATURE	DIMENSION	SECTION	WEIGHT
AFG0028CR	Round conductor (per 80 m)	Bare copper	Ø 8 mm	> 50 mm <sup>2</sup>	440 g/m
AFG2018CR	Round conductor (per 50 m)	Bare copper	Ø 8 mm	> 50 mm <sup>2</sup>	440 g/m
AFG0008CR	Round conductor (per 70 m)	Tinned copper	Ø 8 mm	> 50 mm <sup>2</sup>	440 g/m
AFG2008CR	Round steel conductor	Galvanized steel.	Ø 8 mm	> 50 mm <sup>2</sup>	390 g/m
AFG2018CR	Round conductor	Stainless steel.	Ø 8 mm	> 50 mm <sup>2</sup>	330 g/m
AFG0008BC	3 m bar	Stainless steel.	Ø 8 mm	> 50 mm <sup>2</sup>	1350 g/m

Packaging to be confirmed.

## FLEXIBLE BRAIDS AND MULTI-STRAND CONDUCTORS

For creating equipotential connections of metal masses.



AFG0303CS



AFG5038CR

REFERENCES	DESIGNATION	NATURE	DIMENSIONS	SECTION	WEIGHT
AFG0303CS	Soft braid	Tinned copper	30 x 3 mm	50 mm <sup>2</sup>	0,48 kg
AFG0035CS	Soft braid 35 mm <sup>2</sup>	Tinned copper	Ø 6,7 mm	35 mm <sup>2</sup>	0,32 kg
AFG0016CS	Soft braid 16 mm <sup>2</sup>	Tinned copper	Ø 4,5 mm	16 mm <sup>2</sup>	0,15 kg
AFG5038CR	Stranded conductor 50 mm <sup>2</sup>	Bare copper	Ø 8 mm	50 mm <sup>2</sup>	0,45 kg
AFG5025CR	25 mm <sup>2</sup> stranded conductor	Bare copper	Ø 5,6 mm	25 mm <sup>2</sup>	0,23 kg
AFG0035CR	Stranded conductor 35 mm <sup>2</sup>	Bare copper	Ø 10 mm	35 mm <sup>2</sup>	10 kg

Other dimensions on request.

## ELBOW ON PREFORMED EDGE

The preformed edge bend in tinned copper strip complies with the NF EN 62561-2 standard, making it possible to avoid sudden bends on the down conductors to earth.



AFG0030CC

REFERENCE	DESIGNATION	NATURE	DIMENSIONS (MM)	LENGTH X RADIUS (CM)	WEIGHT
AFG0030CC	Elbow on preformed edge	Tinned copper	27 x 2 mm	70 x 3 cm	270 g

## SHUNTS

Shunts are used to connect metal masses to down conductors.



AFG0230ST



AFG0430ST

REFERENCES	DESIGNATION	NATURE	DIMENSION	SECTION	WEIGHT
AFG0130ST	Shunt tresse souple plate 250 mm	Tinned copper	30 x 3 mm	50 mm <sup>2</sup>	150 g
AFG0230ST	Shunt tresse souple plate 500 mm	Tinned copper	30 x 3 mm	50 mm <sup>2</sup>	250 g
AFG0330ST	Shunt tresse souple plate 750 mm	Tinned copper	30 x 3 mm	50 mm <sup>2</sup>	380 g
AFG0430ST	Shunt tresse souple plate 1000 mm	Tinned copper	30 x 3 mm	50 mm <sup>2</sup>	510 g

Other dimensions on request.

## CLAMPS MASONRY

Clamps are used to fix flat conductors to masonry walls (concrete or bricks). They are used with dowels.



AFH2030CM



AFH2030CC



AFH2030CMA



AFH8030CC

REFERENCES	DESIGNATION	NATURE	LENGTH	WEIGHT
AFH2030CM	Masonry clamp for 30 mm tape	the burdens	50 mm	11 g
AFH2030CC	Ankle for AFH2030CM crampon	Plastic	40 mm	26 g
AFH2030CMA	Masonry clamp for 30 mm tape	the burdens	40 mm	18 g
AFH8030CC	Ankle for AFH2030CMA crampon	Plastic	40 mm	15 g
AFH2031CM	Masonry clamp for 30 mm tape	Galvanized steel	30 mm	-

## STAPLES

Staples are used to fix flat conductors on tiled or slate roofs.



AFH0030AM

REFERENCES	DESIGNATION	NATURE	LENGTH	WEIGHT
AFH0030AM	Flat staple on tile	Tinned copper	150 mm	40 g
AFH0031AM	Flat staple on tile	Tinned copper	100 mm	26 g

## BRIDES

The flanges are used to fix flat conductors to zinc cladding or roofing by welding.



AFH0030BF

REFERENCE	DESIGNATION	NATURE	DIMENSION	WEIGHT
AFH0030BF	Fixing flange for zinc roof	Tinned copper	-	6 g



AFH7000AC

## COLLARS

These clamps allow flat conductors to be fixed to any type of support, favoring concrete and wood supports. Delivered with M7 x 40 steel wood screws.

REFERENCE	DESIGNATION	NATURE	DIMENSION	WEIGHT
AFH7000AC	Flat fixing collar	Brass	50 x 16 mm	26 g



AFH2000AC

## FASTENERS FOR ANGLES, PYLONS, METAL FRAMES

These fasteners allow flat and round conductors to be fixed to metal supports such as angles, pylons or metal frames. They can also be used to make equipotential connections of metallic masses.

REFERENCE	DESIGNATION	NATURE	FIXATION	WEIGHT
AFH2000AC	Framing fastener for round $\varnothing$ 8 or 10	Galvanized steel.	Thickness 10 mm max.	105 g
AFH2001AC	Framing fastener for flat 30 x 2	Galvanized steel.	Thickness 10 mm max.	105 g
AFH2006AC	Framing fastener for flat	Galvanized steel	Thickness 14 to 20 mm max.	16 g



AFH2001AC

## GUTTER PASSAGES

These connections allow the rainwater to be interconnected with the down conductor without any drilling.



AFH2002PG

REFERENCE	DESIGNATION	NATURE	DRIVER	WEIGHT
AFH2002PG	Gutter passage	Galvanized steel	Plate 30 mm+ round $\varnothing$ 10 mm	194 g
AFH2005PG	Gutter passage	Steel/copper	Plate 30 mm+ round $\varnothing$ 10 mm	200 g



AFHI052CS



AFHI053CS



AFHI054CS



AFHI057CS

## CLAMPS

These collars allow the down conductors to be held at the level of extension masts from the Franklin France range and all types of cylindrical elements for a clamping diameter of 8 to 160 mm.

REFERENCES	DESIGNATION	NATURE	LENGTH	CLAMPING DIAMETER	WEIGHT
AFHI051CS	Screw clamp	Stainless steel	8 mm	25 > 45 mm	25 g
AFHI052CS	Screw clamp	Stainless steel	14 mm	35 > 52 mm	26 g
AFHI053CS	Screw clamp	Stainless steel	8 mm	47 > 67 mm	30 g
AFHI054CS	Screw clamp	Stainless steel	8 mm	62 > 82 mm	32 g
AFHI057CS	Ball clamp	Stainless steel	8 mm	8 > 100 mm	8 g
AFHI058CS	Ball clamp	Stainless steel	8 mm	8 > 160 mm	14 g

## CLIPS INOX

The stainless steel clips allow you to fix the strip type conductors to any type of support using a Ø4mm waterproof pop rivet (AFH0075RP), an expansion plug (AFH8050CE), a Ø3.9mm self-drilling screw, a bolt or a max. Ø4mm screw.



AFH6050CL



AFH6501CL

REFERENCES	DESIGNATION	OBSERVATION	WEIGHT
AFH6050CL	Stainless steel clip 26 x 15 mm for flat 27 x 2 mm	Fixing hole Ø 4 mm	2 g
AFH6501CL	Zinc-plated steel clips for Ø 8 round on flat support	Thickness 7 to 11 mm max.	2 g
AFH6502CL	Stainless steel clip. for flat 30x2 and 30x3	Fixing hole Ø 4 mm	2 g
AFH6503CL	Stainless steel clip. for flat 33.5 x 3	Fixing hole Ø 4 mm	2 g

## EXPANDING RIVETS



AFH0075RP



AFH0175RN

REFERENCES	DESIGNATION	NATURE	DIMENSION	THICKNESS	WEIGHT
AFH0075RP	Aluminum waterproof Pop rivet	Aluminium	Ø 4 x 12,5 mm	-	2 g
AFH0175RN	Vulca washers	Aluminium	Ø 10 mm	2 mm	2 g
AFH8050CE	Waterproof anchor with M4 screw	Steel / rubber	Ø 8 x 24 mm	-	33 g



AFH8039PC



AFH8038PC

## CEMENT PADS "CONDUCTOR SUPPORT"

These studs allow flat (27x2 to 33.5x3) or round (Ø8 and 10) conductors to be fixed to the roof without compromising the waterproofing. They can also be installed on green or gravel roofs. This solution also facilitates maintenance or replacement of seals.

REFERENCES	DESIGNATION	NATURE	DIMENSION	WEIGHT
AFH8038PC	Universal concrete pad	Concrete + plastic	98 x 98 x 75,5 mm	1 kg
AFH8039PC	Cement support pad for round or flat conductor with clip	Polypropylene + cement	140 x 140 x 80 mm	1 kg
AFH8040PC	Cement support pad without the fastener	Polypropylene + cement	140 x 140 x 80 mm	1 kg
AFH8041PC	Pedestal to be cemented with the fastener	Polypropylene	140 x 140 x 80 mm	80 g

## UNIVERSAL PLASTIC FASTENERS

These clips are intended for fixing conductors to all types of materials.



AFH6415AC



AFH6416AC



AFH6406AC



AFH6407AC

REFERENCES	DESIGNATION	OBSERVATION	WEIGHT
AFH6414AC	Attachment for flat 30 mm "sole" height 14 mm	For flat or round conductor	23 g
AFH6415AC	Attachment for flat 30 mm "ankle" height 14 mm	For flat or round conductor	23 g
AFH6416AC	Attachment for 30 mm flat "support" height 24 mm	For flat or round conductor	23 g
AFH6405AC	Locking clip without height sole 18 mm	For round conductor Ø 8 mm	8 g
AFH6406AC	Height "sole" locking clip 18 mm	For round conductor Ø 8 mm	10 g
AFH6407AC	Height "ankle" locking clip 18 mm	For round conductor Ø 8 mm	10 g
AFH6408AC	Height "support" locking clip 25 mm	Diameter 10 mm max.	10 g



AFH6420GT



AFH6422AF



AFJ0005RC



AFJ0819RL



AFH1650CC



AFH2650CC



AFH1050SC

## ATTACHMENT SUPPORT ACCESSORIES

These fixings are used to hold conductors on tiled or slate roofs with the AFH6414AC and AFH6406AC fastening models.

REFERENCES	DESIGNATION	NATURE	OBSERVATION	WEIGHT
AFH6418CT	Tile or slate hook	White zinc plated steel	Length 44cm	93 g
AFH6419GT	Tile or slate slide (to be nailed)	White zinc plated steel	Length 23 cm	40 g
AFH6420GT	Tile or slate slide (to be fitted)	White zinc plated steel	Length 40cm	74 g
AFH6421CB	Hook for bolt M 8 x 60	White zinc plated steel	For corrugated sheet roofing	10 g
AFH6422AF	Ridge hook	White zinc plated steel	1/2 circle adjustment 17/24 cm	74 g

## CONDUCTIVE FITTINGS

These fittings are used to make connections between down conductors, mesh or equipotential connections, by mechanical tightening. They allow up to 4 conductors to be connected.

REFERENCES	DESIGNATION	NATURE	OBSERVATION	WEIGHT
AFJ0005RC	"flat-flat" crossover connection	Cupro aluminum, tinned	For 30 mm flat	218 g
AFJ0819RL	"Flat-round" connection	Stainless steel	For flat 25 to 33,5mm and round diameter 8 and 10 mm	100 g

## LUGS - CABLE CLAMPS FOR COPPER LINES

These lugs are mainly used to make connections between different earth networks and/or with a metal structure.

REFERENCES	DESIGNATION	NATURE	DIMENSION	SECTION	TIGHTENING	WEIGHT
AFH1650CC	Cable lug	Brass	43 x 21 mm	6 > 50 mm <sup>2</sup>	2 x M5	40 g
AFH2650CC	Double terminal	Brass	64 x 21 mm	6 > 50 mm <sup>2</sup>	4 x M5	76 g
AFH1050SC	Cable clamps	Brass	28 x 29 x 34 mm	10 > 50 mm <sup>2</sup>	2 x M6	64 g
AFH1695SC	Cable clamps	Brass	36 x 39 x 46 mm	16 > 95 mm <sup>2</sup>	2 X M8	154 g



AFK0080BC

## CONTROL JUNCTION

A control junction (cut-off terminal) must be inserted on each down conductor to enable them to be isolated from the earth network. It is in principle to be installed between the protective sheath (AFK4200FP) and the lightning meters (AFV1007CF, AFV0920CF, AFV0909CF).

REFERENCE	DESIGNATION	NATURE	DIMENSION	WEIGHT
AFK0080BC	Ground breaking terminal	Cupro aluminum. tinned	70 x 37 x 20 mm	360 g



AFK4200FP

## PROTECTIVE TUBE

It allows the protection of down conductors against mechanical shock over a height of 2 meters. It is to be placed between the control junction (AFK0080BC) and the inspection window (AFK8001RV) or the equipotential bonding bar (AFK0020BE). It comes with 3 AFK4203CF clamps.

REFERENCES	DESIGNATION	NATURE	DIMENSION	WEIGHT
AFK4200FP	Protective sheath for flat conductor 30 mm	Galvanized steel	40 x 4 x 2000 mm	1,26 kg
AFK4204FP	Protective sheath for flat conductor 30 mm	Stainless steel	40 x 4 x 2000 mm	830 g
AFK4201FP	Tubular protective sheath	Dichromate steel	Ø 20 x 2000 mm	2,18 kg
AFK4203CF	Fixing collar for AFK4200FP or AFK4204FP	Stainless steel	40 x 4 x 2000 mm	830 g

## MULTI-STRAND CONNECTION

This connector is used to connect the 3 branches of the crow's feet. However, it is possible to connect more than 3 conductors.



AFK0004RM

REFERENCE	DESIGNATION	NATURE	DIMENSION	WEIGHT
AFK0004RM	"Multi-strand" connection	Copper alloy	80 x 80 x 20 mm	930 g

## EARTH GRIDS

They allow the creation and/or improvement of lightning earthing. Each grid is made up of 115 x 40 mm mesh.



AFK0900GT

REFERENCES	DESIGNATION	NATURE	DIMENSION	WEIGHT
AFK0900GT	"Copper" earth grid + adhesive strip	Copper	920 x 660 mm	2,64 kg
AFK0901GT	"Copper" earth grid	Copper	2000 x 1000 mm	7 kg

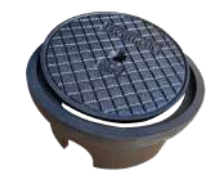

AFK8001RV



AFK8009RV

## INSPECTION PIT

The inspection pit should be placed in the lower part of each down conductor. It allows the disconnection of the lightning earth connection, the down conductor and the equipotential connection with the general earth network of the site (excavation bottom, TGBT, etc.).

REFERENCES	DESIGNATION	NATURE	DIMENSION	WEIGHT
AFK8001RV	Inspection pit	Cast iron	Ø 230 mm	4,9 kg
AFK8009RV	Inspection pit	Polyethylene	Ø 340 mm	2,4 kg



AFK2020BE



AFK0420PT

## COPPER - EARTH RODS

The rods are used to create lightning or electrical earth connections. They are self-extending by elements. The bore at the rods head is pre-greased, the interlocking element is knurled, which allows interlocking and lasting contact. The use of a suitable striking head makes it possible to drive the rods without damaging the technical and functional parts. Driving by mechanical percussion with an electric or thermal hammer is necessary as soon as a certain number of rods must be installed and/or for deep installations.

REFERENCES	DESIGNATION	DIAMETER	LENGTH	WEIGHT
AFK0420PT	Copper-steel stake 250 µm self-extending	17,4 mm	1 m	1,9 kg
AFK2020BE	Manual driving pin	-	-	228 g



AFK0102PT

## GALVANIZED STEEL EARTH RODS

These non-extendable rods are mainly used for creating electrical earth connections. They are equipped with a connection collar.

REFERENCES	DESIGNATION	DIAMETER	LENGTH	WEIGHT
AFK0101PT	Galvanized steel stake	21 mm	1 m	1,18 kg
AFK0102PT	Galvanized steel stake	21 mm	1,5 m	1,69 kg

## STAINLESS STEEL EARTH RODS



AFK1029PT

These rods are used to create lightning or electrical earth connections. They are self-extending by elements and made of stainless steel tube Ø 16mm. Driving by mechanical percussion with an electric or thermal hammer is necessary as soon as a certain number of rods must be installed and/or for deep installations.

REFERENCE	DESIGNATION	DIAMETER	LENGTH	WEIGHT
AFK1029PT	Self-extending stainless steel stake	16 mm	1 m	1,48 kg
AFK1031PT	Self-extending stainless steel stake	16 mm	1,5 m	2,25 kg



AFK0020RP

## CONNECTION COLLAR FOR EARTH RODS

Allows the connection of horizontal strip-type electrodes with vertical electrodes.

REFERENCE	DESIGNATION	DIAMETER	LENGTH	WEIGHT
AFK0020RP	Stake connection collar	16/17,4 mm	-	150 g



AFK0020BE

## EQUIPOTENTIALITY BARS AND CLAMPS

These pre-drilled bars are used for the equipotential connection of different earth conductors (cable, round or flat) with the possibility of disconnecting. Fixing on a wall, on a rack frame, bay, etc. or next to a concrete inspection. Equipotential clamps allow pipes and other metal masses to be connected to the equipotential network.



AFH8102BE

REFERENCES	DESIGNATION	NATURE	DIMENSION	WEIGHT
AFK0020BE	Equipotential bar 2 x 8 holes - Ø 10 + insulators	Copper	200 x 50 x 5 mm	600 g
AFK0125BE	Equipotential bar 70 holes - Ø 10	Copper	1750 x 25 x 5 mm	1,7 kg
AFH4000IT	Earth bar insulator	Polyamide	Ø 40 x 40 mm	100 g
AFH8100CE	Clamp for equipotentiality	Stainless steel	Ø 8-32 mm	46 g
AFH8102CE	Clamp for equipotentiality	Stainless steel	Ø 32-100 mm	50 g

## GROUND COIL

This coil is placed in series on the equipotential connection of two earth connections. For example between a lightning earth connection and the mass earth connection. It increases the link impedance, which, in the case of a short connection, limits the shock effect and the transmission of energy to the electrical distribution while maintaining equipotentiality. It is placed as close as possible to the ground of the masses (accesshole or base of the wall).



AFK0001ST

REFERENCE	DESIGNATION	DIMENSION	WEIGHT
AFK0001ST	Earth choke	225 x 68 x 102 mm	1,33 g

## EQUIPOTENTIALITY SPARK PLUGS AND ANTENNA MASTS

The spark plugs ensure the balancing of the potentials of the different earths. To avoid damage and limit risks, it is recommended to insert antenna mast spark gaps on the grounding circuit.



AFY7600EA

REFERENCES	AFY7600EA	AFK0112BE	AFK0113EE
Application	Antennas, TV, ...	Risk of corrosion	Approximately explosive, cathodic protection
Nature	Stainless steel + resin	Stainless steel + PVC	Zinc + PVC
Discharge current	100 kA - 10 x (onde 8/20)	100 kA - 10 x (onde 8/20)	100 kA - 10 x (onde 8/20)
Protection level Up (start-up voltage, wave of 1.2/50)	1,5 kV	4 kV	2,2 kV
Connection	By necklaces	Bar Ø 8 mm	2 x M 10 (230 mm cable)
Protection sign	IP65	IP65	Ex(s) G4
Dimension	180 x 50 x 40 mm	Ø 45 x 160 mm	Ø 63 x 90 mm
Weight	350 g	290 g	850 g



AFK0113EE

## NAMEPLATES - LIGHTNING EARTHING MARKERS

Each down conductor and lightning earth connection must be equipped with this nameplate, to prevent a risk of contact or step voltage. It must be readable from 3 meters away and must be installed at reading height.



AFH8000GB

REFERENCES	DESIGNATION	NATURE	DIMENSION	WEIGHT
AFH8000PS	Nameplate	Aluminium	137 x 137 x 137 mm	110 g
AFH8000GB	Nameplate in English	Aluminium	137 x 137 x 137 mm	110 g
AFH8000ES	Nameplate in Spanish	Aluminium	137 x 137 x 137 mm	110 g

## EARTH MEASURER

The AFM2408TL earth measurer is a stand-alone and versatile product that allows you to measure the resistance of an earth connection, but also the resistivity of the ground. This device is delivered with all the equipment necessary for the various measurements.

REFERENCE	AFM2408TL
Measurement range	Resistance : 0 - 20 kΩ Voltage : 0 - 200 V~
Resolution	Resistance : 0.01 Ω Voltage : 0.1 V
Operating temperature	- 10 °C / + 50 °C
Battery	NiMH Rechargeable Battery AC Adapter 12 V - 1 A
Dimension	221 x 189 x 99 mm
Weight	≈ 1.5 kg



## GROUND IMPROVER - TEREC+

The TEREC+ ground improver is made of highly conductive materials which increase the efficiency of the earth connection. It is widely used in cases where soil resistivity is high, and in the presence of erosion due to flooding.

REFERENCE	AFK0040AT
Designation	Soil improver
Weight	15 Kg





## ARGOSWELD® ALUMINOTHERMIC WELDS

ARGOSWELD® aluminothermic welding solutions allow you to connect different types of conductors safely, reliably, simply and quickly (flat conductor, round conductor, reinforcing steel, steel, earth rod, etc.).

The principle consists of bringing together a filler metal and a priming product in a suitable mold.

Under very high temperatures, the copper will melt, then flow inside the mold onto the parts to be welded in order to bond them together.

This system does not require any external power supply.

To facilitate implementation and ensure user safety, Franklin France has developed a complementary ARGOS E-WELD range with:

- A remote electronic igniter equipped with a wired connection to connect it to the capsule, thus ensuring that a safe distance is maintained during use.
- A copper capsule system containing the solder powder. Unlike tubes, it does not require lighting powder. Eco-friendly, this innovation generates less residue.



REFERENCE	DESIGNATION	NATURE	OBSERVATION	WEIGHT
ARG0025MA	Filler metal	Powder	-	25 g
ARG00250MA	Filler metal	Powder	-	250 g
ARGBB14253	BB1 mold 25x3mm straight	Graphite standard	For 80-100 welds	1,6 kg
ARGBR24142253	BR2 mold 25x3mm + Stake	Graphite standard	For 30 mm flat	1,6 kg
ARGCC2495	CC2 cable to cable mold 95mm <sup>2</sup> T	Graphite standard	Pours around 95 mm <sup>2</sup>	1,6 kg
ARGCR1414216	Cable mold 16 mm <sup>2</sup> - 5/8 stake	Graphite standard	Pours around 16 mm <sup>2</sup>	1,6 kg

The soldering kit is delivered with the ignition powder, in tubes or capsules of 25 to 400 grams depending on the type and number of connections desired. In addition, it is possible to have all the accessories for protecting and cleaning the mold (case, gloves, pliers, brush, file, etc.).

## FLAT AND FLAT



## CABLE AND CABLE



## CABLE AND IRON CONCRETE

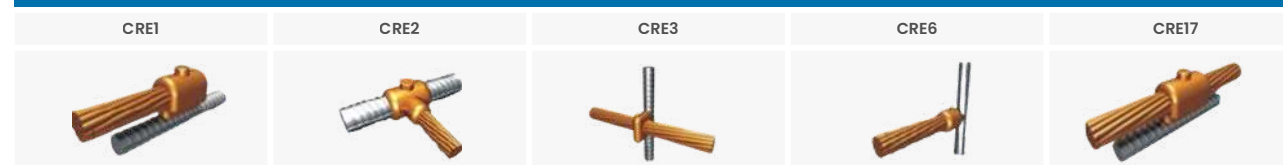

## CABLE AND STEEL



## FLAT AND CABLE



## CABLE AND GROUND STAKE



## FLAT AND EARTH STAKE



## FLAT AND STEEL

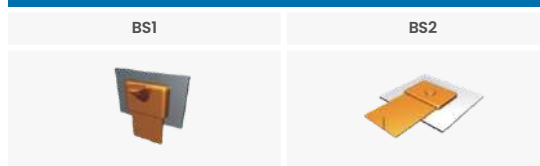



SURGE PRODUCTS

# RULES OF INSTALLATION

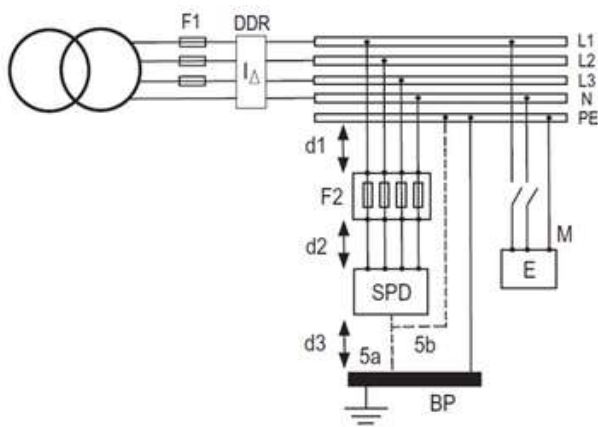

F1 and F2: fuses or circuit breaker

SPD: lightning arrester

BP : main borne de terre

Total length  $d1 + d2 + d3 < 50$  cm or failing that must be as short as possible

- The surge protector will be connected as a short branch to the power supply concerned.
- In addition to the integrated thermal disconnection, protection against end-of-life short circuits will be inserted upstream of the surge arrester connection. The connection diagram will be determined according to whether priority is given to continuity of service or that of protection.
- It is possible to obtain both continuity of service and continuity of protection through the use of several identical surge arresters mounted in parallel and each equipped with a disconnector.
- In association with modular surge arresters, either fuses or circuit breakers will be chosen (the choice of equipment will be made according to the manufacturer's data and in order to best respect selectivity). This insertion must take into account the number of poles to be protected and the possible short-circuit current at the point considered.
- It is mandatory to provide protection with type I surge arresters if the structure has a lightning protection system (LPS).
- The mandatory conductor section for type 1 surge protectors is 10 mm<sup>2</sup> and 4 mm<sup>2</sup> for types 2 and 3.

# PROTECTION AGAINST OVERVOLTAGE

The indirect effects of lightning are numerous. This is why it must be faced by protecting all electrical, electronic and computer elements. It is with this in mind that all surge protection products have been created.

## Choice of surge protectors:

Common rules valid for all ranges to ensure the safety of people and the operation of products in the best conditions:

- The choice of the protection level Up and the flow current Iimp depend on the electrical sensitivity and also on the presence or not of a Lightning Protection System (SPF) on the building.
- For Telecoms and coaxial protections, it will be necessary to take into account in addition the Up protection level, the operating frequency (Bandwidth), the attenuation and the voltage of the communications network.
- The choice of surge protector will be made easier by the markings made compulsory by the IEC / NF EN 61-643-11 standard.
- The end of life of surge arresters must be studied so that it is not harmful to the equipment to be protected (need to add cutting elements for energy network surge arresters).

## Wiring and grounding:

- The cables will be routed away from other conductors and the earthing will also be as short as possible on the equipotential bar or the cabinet ground.
- We will thus seek to optimize the route of the conductors by ensuring that the arrival wires on the surge protector are clearly distinct from those leaving.
- The feeders protected by a surge arrester will be taken from the terminals of the surge arrester and switching device dedicated to end-of-life protection.
- The total length of the connections, protection device and protection included, must not exceed 50 cm.
- No separate earth connection should exist.
- If in a panel or cabinet, the connection to the general earth is too far away, we will use an intermediate earth terminal block (UTE-C 15 443).
- An earth connection per building or protected installation is required.
- To optimize the installation, the resistance of this earth connection must have the lowest possible HF impedance. It should be checked that connections to separate earth socket distributions where equipotentiality is far away do not coexist within the same building or electrical cabinet.
- All these installation rules are valid for all protections.

## Choice of material:

- The choice of surge protectors to install depends on the performance of the electrical equipment to be protected. The characteristics of surge arresters have been studied to be able to protect at all levels of an electrical installation.

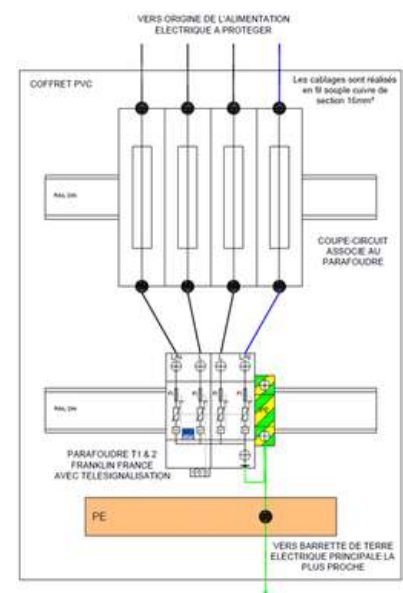
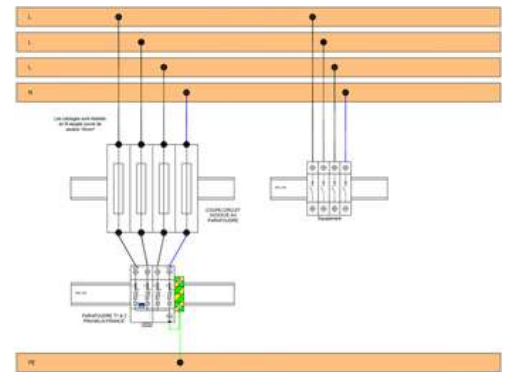
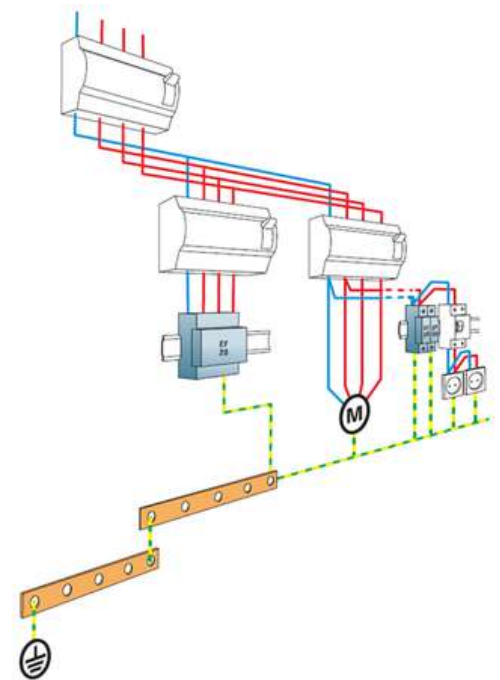

# LV MULTIPOLAR ARRESTERS TYPE 1+2 MODE C1

The PFTIV13, PFTIV13M, PFTIV13T are plug-out Type 1+2 surge arresters, of very high power, intended to be installed at the entrance to the low-voltage installation when it is equipped with a lightning rod. The 'Multi-Varistor' technology used provides a very high discharge current and the best possible behavior for the LV network (no follow-on current). Given their very high discharge capacity, these surge protectors are particularly compact and are offered in a multi-pole version to protect single or three-phase networks.

REFERENCES		ASS8240PF2	ASS8254PF2	ASS8259PF2
DESIGNATION		PFTIV13	PFTIV13M	PFTIV13T
ELECTRICAL SPECIFICATIONS				
TYPE OF SURGE PROTECTOR		1+2		
TECHNOLOGY		MOV		
SURGE PROTECTOR CONFIGURATION		Unipolar	Single phase	Tri+N
CONNECTION MODE		-	C1 (2+0)	C1 (4+0)
NEUTRAL SYSTEM		IT - TNS - TNC	IT - TNS	IT - TNS
MAX AC VOLTAGE OPERATING		Uc	440 Vac	
MAX LIGHTNING CURRENT PER POLE - MAXIMUM WAVE STRENGTH 10/350MS		Iimp	12.5 kA	
TOTAL SHOCK CURRENT - MAX. WITHSTAND TOTAL WAVE 10/350MS		Itotal	-	25 kA 50kA
RATED DISCHARGE CURRENT - 15 SHOCKS UNDER 8/20MS WAVE		In	20 kA	
MAXIMUM DISCHARGE CURRENT - MAXIMUM WAVE WITHSTAND 8/20MS		I <sub>max</sub>	50 kA	
PROTECTION LEVEL (AT IN 8/20MS)		Up	1,7 kV	
PROTECTION LEVEL (AT 5KA 8/20MS)		Up 5kA	1,5 kV	
ASSOCIATED DISCONNECTORS				
FUSES		125 A min. 315 A max. type gG ou SFD-13		
MECHANICAL CHARACTERISTICS				
END OF LIFE INDICATOR		Mechanical indicator		
REMOTE SIGNALING		Output on changeover contact		
COMPLIANCE WITH STANDARDS		IEC 61643-11 / NF EN 61643-11		



# LV MULTIPOLAR ARRESTERS TYPE 1+2 MODE C2

The PFTIV13-C2M and PFTIV13-C2T are plug-in Type 1+2 surge arresters, of very high power, intended to be installed at the entrance to the Low Voltage installation when it is equipped with a lightning rod. The 'Multi-Varistor' technology used provides a very high discharge current and the best possible behavior for the LV network (no follow-on current). Given their very high discharge capacity, these surge protectors are particularly compact and are offered in a multi-pole version to protect single or three-phase networks.

REFERENCES		ASS8241PF2	ASS8242PF2
DESIGNATION		PFTIV13-C2M	PFTIV13-C2T
ELECTRICAL SPECIFICATIONS			
TYPE OF SURGE PROTECTOR		1+2	
TECHNOLOGY		IOC+GSG	
SURGE PROTECTOR CONFIGURATION		Single phase	Tri+N
CONNECTION MODE		C2 (1+1)	C2 (3+1)
NEUTRAL SYSTEM		TT - TNS	TT - TNS
MAX AC VOLTAGE OPERATING		Uc	275 Vac
MAX LIGHTNING CURRENT PER POLE - MAXIMUM WAVE STRENGTH 10/350MS		Iimp	12.5 kA
TOTAL SHOCK CURRENT - MAX. WITHSTAND TOTAL WAVE 10/350MS		Itotal	25 kA      50 kA
RATED DISCHARGE CURRENT - 15 SHOCKS UNDER 8/20MS WAVE		In	20 kA
MAXIMUM DISCHARGE CURRENT - MAXIMUM WAVE WITHSTAND 8/20MS		I <sub>max</sub>	50 kA
PROTECTION LEVEL L/N (AT IN 8/20MS)		Up L/N	1,3 kV
PROTECTION LEVEL L/N (AT 5KA 8/20MS)		Up 5kA	1 kV      1.2 kV
PROTECTION LEVEL N/PE (AT 5KA 8/20MS)		Up 5kA	1 kV      1.2 kV
ASSOCIATED DISCONNECTORS			
FUSES		125 A min. 315 A max. type gG ou SFD-13	
MECHANICAL CHARACTERISTICS			
END OF LIFE INDICATOR		Mechanical indicator	
REMOTE SIGNALING		Output on changeover contact	
COMPLIANCE WITH STANDARDS		IEC 61643-11 / NF EN 61643-11	



# LV UNIPOLAR ARRESTERS TYPE 1+2+3

The PFT1EV25 are single-pole Type 1+2+3 surge protectors, of very high power, intended to be installed at the entrance to the Low Voltage installation. They make it possible to protect single-phase or three-phase networks in common mode or in common and differential mode. The `Eclateur + Varistor` technology allows a very low level of protection and an absence of follow-on current. The FT1EV25 is installed on DIN Rail and has a double connection for the active conductor, which allows an optimized connection to the network. The FT1EV25 surge protectors are intended to be mounted in multi-pole to protect single, three or three-phase + Neutral networks, sometimes associated with a specific N/PE surge protector.

REFERENCES		ASS8204PF2
DESIGNATION		PFT1EV25
<b>ELECTRICAL SPECIFICATIONS</b>		
TYPE OF SURGE PROTECTOR		1+2+3
TECHNOLOGY		Varistor + Specific gas gap
SURGE PROTECTOR CONFIGURATION		Unipolar
NEUTRAL SYSTEM		TT – TNS (C2 mode with DI surge protector for N/PE)
MAX AC VOLTAGE STEADY STATE	Uc	440 Vac
MAX LIGHTNING CURRENT PER POLE – MAXIMUM WAVE STRENGTH 10/350MS	Iimp	25 kA (associated with SFDI-25 or 315A gG fuse)
		12.5 kA (associated with SFDI-13 or 125A gG fuse)
RATED DISCHARGE CURRENT – 15 SHOCKS UNDER 8/20MS WAVE	In	30 kA
MAXIMUM DISCHARGE CURRENT – MAXIMUM WAVE WITHSTAND 8/20MS	I <sub>max</sub>	70 kA
PROTECTION LEVEL AT IN (8/20MS) AND AT 6 KV (1.2/50 MS)	Up	1,5 kV
PROTECTION LEVEL (AT 5KA 8/20MS)	Up 5kA	1 kV
<b>ASSOCIATED DISCONNECTORS</b>		
FUSES		125 A min. – 315 A max. or SFDI-13 – SFDI-25
<b>MECHANICAL CHARACTERISTICS</b>		
END OF LIFE INDICATOR		Mechanical indicator
REMOTE SIGNALING		Output on changeover contact
COMPLIANCE WITH STANDARDS		IEC 61643-11 / NF EN 61643-11

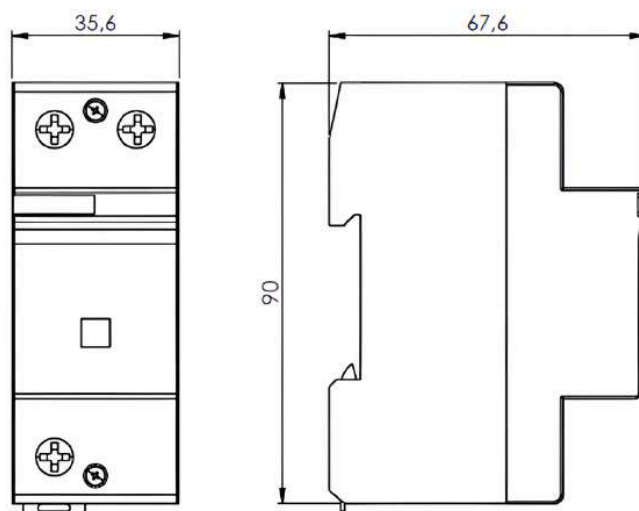

# SURGE ARRESTERS N/PE UNIPOLAR

Single-pole Type 1+2+3 surge protectors, of very high power, intended to be installed at the entrance to the Low Voltage installation. They make it possible to protect single-phase or three-phase networks in common mode or in common and differential mode. The "Eclateur + Varistor" technology allows a very low level of protection and an absence of follow-on current. The surge protector is installed on a DIN Rail and has a double connection for the active conductor, which allows an optimized connection to the network. Surge protectors are intended to be mounted in multi-pole to protect single, three or three-phase + Neutral networks, sometimes associated with a specific N/PE surge protector.

REFERENCES		ASS8250PF2
DESIGNATION		PFT1E100
ELECTRICAL SPECIFICATIONS		
TYPE OF SURGE PROTECTOR		N/A
TECHNOLOGY		Specific gas gap
SURGE PROTECTOR CONFIGURATION		Unipolar
NEUTRAL SYSTEM		TT - TNS (mode C2)
MAX VOLTAGE STEADY STATE	Uc	255 Vac
MAX LIGHTNING CURRENT PER POLE - MAXIMUM WAVE STRENGTH 10/350MS	Iimp	100 kA
RATED DISCHARGE CURRENT - 15 SHOCKS UNDER 8/20MS WAVE	In	100 kA
MAXIMUM DISCHARGE CURRENT - MAXIMUM WAVE WITHSTAND 8/20MS	I <sub>max</sub>	100 kA
PROTECTION LEVEL AT IN (8/20MS)	Up	1,5 kV
PROTECTION LEVEL (AT 5KA 8/20MS)	Up 5kA	1 kV
MECHANICAL CHARACTERISTICS		
END OF LIFE INDICATOR		Non
REMOTE SIGNALING		Non
COMPLIANCE WITH STANDARDS		IEC 61643-11 / NF EN 61643-11

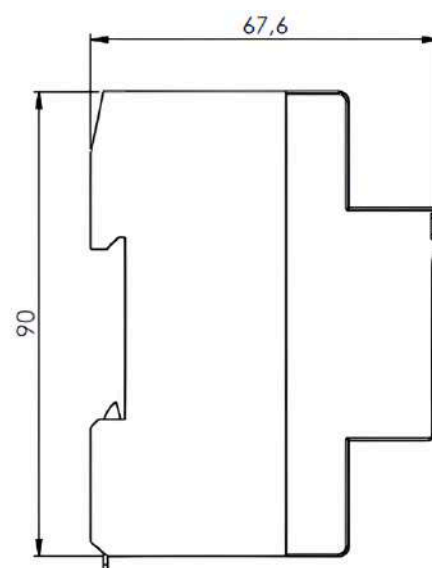
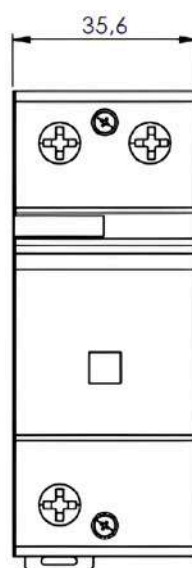

# LV MULTIPOLAR ARRESTERS TYPE 1+2+3 MODE C2

Single-pole Type 1+2+3 surge arresters, of very high power, intended to be installed at the entrance to the Low Voltage installation. They make it possible to protect single-phase or three-phase networks in common mode or in common and differential mode. The "Eclateur + Varistor" technology allows a very low level of protection and an absence of follow-on current. The surge protector is installed on a DIN Rail and has a double connection for the active conductor, which allows an optimized connection to the network. Surge protectors are intended to be mounted in multi-pole to protect single, three or three-phase + Neutral networks, sometimes associated with a specific N/PE surge protector.

<b>REFERENCES</b>		ASS8204PF2 (X3) + ASS8250PF2
<b>DESIGNATION</b>		PMTIEV25 (x3) + PFTIE100
<b>ELECTRICAL SPECIFICATIONS</b>		
<b>TYPE OF SURGE PROTECTOR</b>		1+2+3
<b>TECHNOLOGY</b>		Varistor + Specific gas gap
<b>SURGE PROTECTOR CONFIGURATION</b>		3Ph+N
<b>CONNECTION MODE</b>		C2 (3+1)
<b>NEUTRAL SYSTEM</b>		TT – TNS
<b>TENSION MAX. DE RÉGIME PERMANENTLY</b>		Uc 440 Vac
<b>MAX LIGHTNING CURRENT PER POLE – MAXIMUM WAVE STRENGTH 10/350MS</b>		limp 25 kA (associated with SFD1-25 or 315A gG fuse) 12.5 kA (associated with SFD1-13 or 125A gG fuse)
<b>RATED DISCHARGE CURRENT – 15 SHOCKS UNDER 8/20MS WAVE</b>		In 30 kA
<b>MAXIMUM DISCHARGE CURRENT – MAXIMUM WAVE WITHSTAND 8/20MS</b>		Imax 70 kA
<b>PROTECTION LEVEL AT IN (8/20MS) AND AT 6 KV (1.2/50 MS)</b>		Up 1,5 kV
<b>PROTECTION LEVEL (AT 5KA 8/20MS)</b>		Up 5kA 1 kV
<b>ASSOCIATED DISCONNECTORS</b>		
<b>FUSES</b>		125 A min. – 315 A max. or SFD1-13 – SFD1-25
<b>MECHANICAL CHARACTERISTICS</b>		
<b>END OF LIFE INDICATOR</b>		Mechanical indicator
<b>REMOTE SIGNALING</b>		Output on changeover contact
<b>COMPLIANCE WITH STANDARDS</b>		IEC 61643-11 / NF EN 61643-11



# LV UNIPOLAR ARRESTERS TYPE 2

Type 2 PFT2V20 plug-in surge protectors are used for the protection of low voltage networks at the TGBT level. Based on high-power varistor technology equipped with disconnecter and associated indicator, these surge protectors guarantee maximum protection efficiency, flow capacity and reliability. PFT2V20 surge protectors are available in a multi-pole version and in multiple voltages to protect all types of single-phase or three-phase networks.

REFERENCES		ASS8211PF2
DESIGNATION		PFT2V20
ELECTRICAL SPECIFICATIONS		
TYPE OF SURGE PROTECTOR		2
TECHNOLOGY		MOV
SURGE PROTECTOR CONFIGURATION		Unipolar
NEUTRAL SYSTEM		IT - TNS - TNC
MAX AC VOLTAGE OPERATING	Uc	440 Vac
RATED DISCHARGE CURRENT - 15 SHOCKS UNDER 8/20MS WAVE	In	20 kA
MAXIMUM DISCHARGE CURRENT - MAXIMUM WAVE WITHSTAND 8/20MS	Imax	50 kA
PROTECTION LEVEL AT IN 8/20MS	Up	2 kV
PROTECTION LEVEL AT 5 KA 8/20MS	Up 5kA	1,5 kV
ASSOCIATED DISCONNECTORS		
FUSES		50 A min. - 125 A max type gG
MECHANICAL CHARACTERISTICS		
END OF LIFE INDICATOR		Mechanical indicator
REMOTE SIGNALING		Output on changeover contact
COMPLIANCE WITH STANDARDS		IEC 61643-11 / NF EN 61643-11

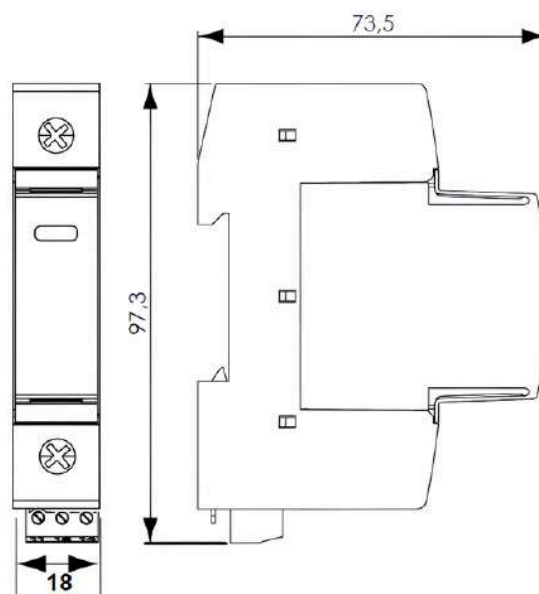

# LV MULTIPOLAR ARRESTERS TYPE 2 MODE C2

The PFT2V20-C2M and PFT2V20-C2T Type 2 pluggable surge arresters are used for the protection of low voltage networks at the TGBT level. Based on high-power varistor technology equipped with disconnecter and associated indicator, these surge protectors guarantee maximum protection efficiency, flow capacity and reliability. These surge protectors are available in a multi-pole version and in multiple voltages to protect all types of single-phase or three-phase networks.

REFERENCES		ASS8233PF2	ASS8234PF2
DESIGNATION		PFT2V20-C2M	PFT2V20-C2T
ELECTRICAL SPECIFICATIONS			
TYPE OF SURGE PROTECTOR		2 (or 3)	
TECHNOLOGY		IOC+GSG	
SURGE PROTECTOR CONFIGURATION		Single phase	Tri + N
CONNECTION MODE		C2 (1+1)	C2 (3+1)
NEUTRAL SYSTEM		TT – TNS	
MAX. AC VOLTAGE OPERATING	Uc	275 Vac	
RATED DISCHARGE CURRENT – 15 SHOCKS UNDER 8/20MS WAVE	In	20 kA	
MAXIMUM DISCHARGE CURRENT – MAXIMUM WAVE WITHSTAND 8/20MS	Imax	50 kA	
PROTECTION LEVEL L/N AT 5KA 8/20MS	Up 5kA	1 kV	
PROTECTION LEVEL N/PE AT 5KA 8/20MS	Up 5kA	1 kV	
ASSOCIATED DISCONNECTORS			
FUSES		50 A min. – 125 A max type gG	
MECHANICAL CHARACTERISTICS			
END OF LIFE INDICATOR		Mechanical indicator	
REMOTE SIGNALING		Output on changeover contact	
COMPLIANCE WITH STANDARDS		IEC 61643-11 / NF EN 61643-11	



# SINGLE-POLE LV SURGE PROTECTORS TYPE 2 (OR 3)

The products in the range have the particularity of integrating the upstream fuse, which saves space in the electrical installation estimated at 60%. PFT2VF05 type 2 (or 3) pluggable surge arresters are used for the protection of low voltage networks at the TGBT level. In addition to their thermal disconnecter linked to the varistor, they are internally equipped with protection against short-circuit currents, which avoids the use of a fuse or additional external circuit breaker as required by standardization. Operation of one of the two disconnectors will activate the fault indicator and remote signaling (option). This solution allows for simplification of implementation and compactness of installation. The PFT2VF05 are intended to be mounted in multipole to protect single and three-phase networks.

REFERENCES		ASS8230PF2
DESIGNATION		PFT2VF05
ELECTRICAL SPECIFICATIONS		
TYPE OF SURGE PROTECTOR		2 (or 3)
TECHNOLOGY		MOV
SURGE PROTECTOR CONFIGURATION		Unipolar
NEUTRAL SYSTEM		IT - TNS - TNC
MAX AC VOLTAGE OPERATING	Uc	440 Vac
RATED DISCHARGE CURRENT - 15 SHOCKS UNDER 8/20MS WAVE	In	5 kA
MAXIMUM DISCHARGE CURRENT - MAXIMUM WAVE WITHSTAND 8/20MS	Imax	15 kA
PROTECTION LEVEL (AT IN 8/20MS)	Up	1,5 kV
ASSOCIATED DISCONNECTORS		
FUSES		Internal (AC equivalent rating: 25A type gG)
MECHANICAL CHARACTERISTICS		
END OF LIFE INDICATOR		Mechanical indicator
REMOTE SIGNALING		Output on changeover contact
COMPLIANCE WITH STANDARDS		IEC 61643-11 / NF EN 61643-11

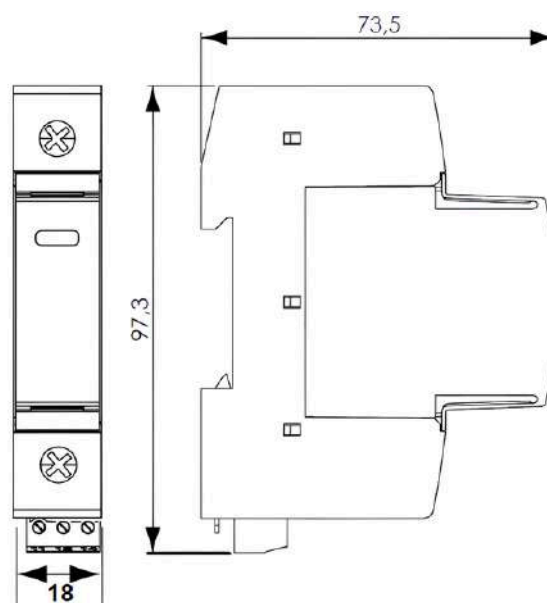

# MULTIPOLAR LV SURGE ARRESTERS TYPE 2 (OR 3) MODE C2

The products in the range have the particularity of integrating the upstream fuse, which saves space in the electrical installation estimated at 60%. PFT2VF05-C2 type 2 (or 3) pluggable surge arresters are used for the protection of low voltage networks at the TGBT level. In addition to their thermal disconnecter linked to the varistor, they are internally equipped with protection against short-circuit currents, which avoids the use of a fuse or additional external circuit breaker as required by standardization. Operation of one of the two disconnectors will activate the fault indicator and remote signaling (option). This solution allows for simplification of implementation and compactness of installation. The PFT2VF05-C2 are intended to be mounted in multi-pole to protect single and three-phase networks.

REFERENCES		ASS8243PF2	ASS8244PF2
DESIGNATION		PFT2VF05-C2M	PFT2VF05-C2T
ELECTRICAL SPECIFICATIONS			
TYPE OF SURGE PROTECTOR		2 (or 3)	
TECHNOLOGY		IOC+GSG	
SURGE PROTECTOR CONFIGURATION		Single phase	Tri + N
CONNECTION MODE		C2 (1+1)	C2 (3+1)
NEUTRAL SYSTEM		TT – TNS	
MAX. AC VOLTAGE OPERATING		Uc	275 Vac
RATED DISCHARGE CURRENT – 15 SHOCKS UNDER 8/20MS WAVE		In	5 kA
MAXIMUM DISCHARGE CURRENT – MAXIMUM WAVE WITHSTAND 8/20MS		I <sub>max</sub>	15 kA
ASSOCIATED DISCONNECTORS			
FUSES		Internal (AC equivalent rating: 25A type gG)	
MECHANICAL CHARACTERISTICS			
END OF LIFE INDICATOR		Mechanical indicator	
REMOTE SIGNALING		Output on changeover contact	
COMPLIANCE WITH STANDARDS		IEC 61643-11 / NF EN 61643-11	



# SPECIFIC SURGE ARRESTER DISCONNECTORS

The SFD range has been specially designed to be associated with a Type 1 AC SPD. The specific FRANKLIN FRANCE fuses have a high flow capacity to protect the SPDs from short circuit failure. Standards: In order to comply with IEC 61643-11 standards, the AC power SPD must be protected against short circuit failure: these specific fuse disconnectors must be installed in the SPD branch.

REFERENCES	ASS1414CC	ASS1403CC	ASS1402CC
DESIGNATION	2P circuit breaker with SFD1-13S fuses	3P circuit breaker with SFD1-13S fuses	4P circuit breaker with SFD1-13S fuses
<b>ELECTRICAL SPECIFICATIONS</b>			
MAX AC VOLTAGE OPERATING	Uc	500 Vac	
MAX LIGHTNING CURRENT PER POLE - MAXIMUM WAVE RESISTANCE 10/350MS	Iimp	12.5 kA	
RATED DISCHARGE CURRENT - 15 SHOCKS UNDER 8/20MS WAVE	In	12.5 kA	
MAXIMUM DISCHARGE CURRENT - MAXIMUM WAVE RESISTANCE 8/20MS	I <sub>max</sub>	80 kA	
<b>MECHANICAL CHARACTERISTICS</b>			
END OF LIFE INDICATOR	Striker		
REMOTE SIGNALING	Yes		
COMPLIANCE WITH STANDARDS	NF 61643-11 / IEC 61643-11 / NF 60269-1 / NF 60269-2 / IEC 60269-1 / IEC 60269-2		

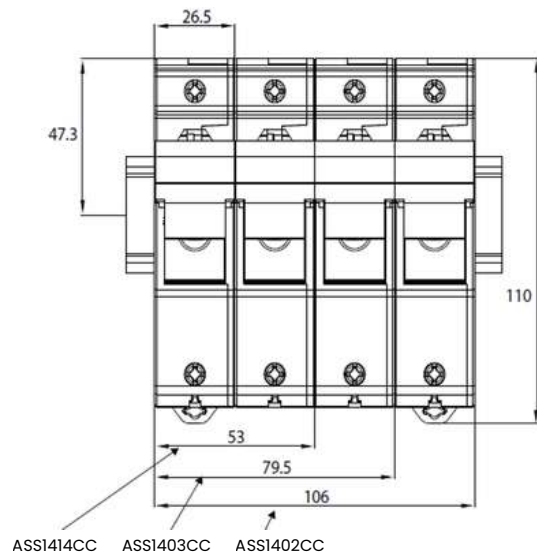
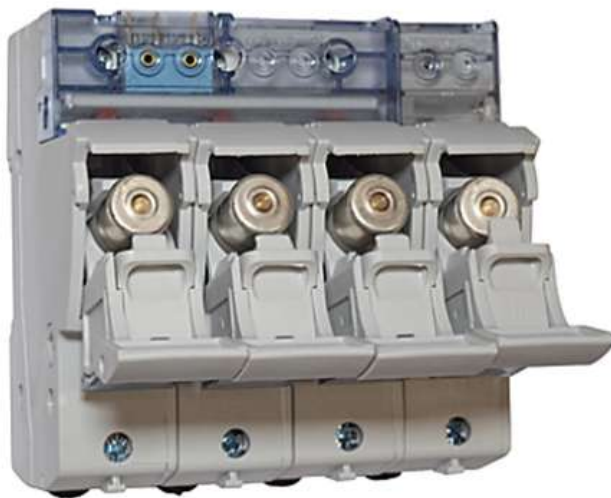

# SPECIFIC SURGE ARRESTER DISCONNECTORS

The SFD range has been specially designed to be associated with a Type 1 AC SPD. The specific FRANKLIN FRANCE fuses have a high flow capacity to protect the SPDs from short circuit failure. Standards: In order to comply with IEC 61643-11 standards, the AC power SPD must be protected against short circuit failure: these specific fuse disconnectors must be installed in the SPD branch.

REFERENCES	ASS1409CC	ASS1408CC	ASS1406CC
DESIGNATION	2P circuit breaker with SFD1-25S fuses	3P circuit breaker with SFD1-25S fuses	4P circuit breaker with SFD1-25S fuses
<b>ELECTRICAL SPECIFICATIONS</b>			
MAX AC VOLTAGE OPERATING	Uc	500 Vac	
MAX LIGHTNING CURRENT PER POLE - MAXIMUM WAVE RESISTANCE 10/350MS	limp	25 kA	
RATED DISCHARGE CURRENT - 15 SHOCKS UNDER 8/20MS WAVE	In	80 kA	
MAXIMUM DISCHARGE CURRENT - MAXIMUM WAVE RESISTANCE 8/20MS	Imax	100 kA	
<b>MECHANICAL CHARACTERISTICS</b>			
END OF LIFE INDICATOR	IP20		
REMOTE SIGNALING	Yes		
COMPLIANCE WITH STANDARDS	NF 61643-11 / IEC 61643-11 / NF 60269-1 / NF 60269-2 / IEC 60269-1 / IEC 60269-2		

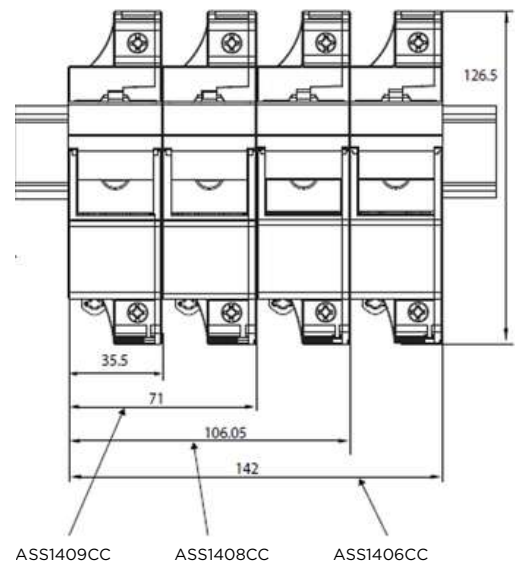



ASSOCIATED PRODUCTS

# STORMDETEC – STORM DETECTOR™

Advanced detection of storms makes it possible, with an anticipation period, to implement procedures of protection, to limit the importance of the destructive effects of storms to reduce their impact and economic cost to :

- Risks incurred by people,
- Risks linked to destruction, production hazards of goods or services.

The STORMDETEC™ (AVF3000DF) is a new generation storm detector for professional use, measuring variations in the electrostatic field of the atmospheric layer close to the ground based on the so-called "field mill" technique.

Its principle is based on the real-time and continuous measurement of the local electrostatic field and on the instantaneous recognition of symptomatic developments in this field which determine the high probability of an imminent storm with a local risk of lightning.

The STORMDETEC™ is a professional storm detector with a wide spectrum of use, fully configurable according to the characteristics of the risk policy implemented by the user, mainly by adjusting the levels of the alarm thresholds, but also by the adjustment of its environment coefficient to compensate for the influence of the environment of the site on which it is installed.

The STORMDETEC comes with:

- A control box (CCA)
- An electrostatic field measuring head (TMC)
- 20 m of cable to connect the measuring head (TMC) with the control box (CCA),
- 5 m of cable to connect the CCA to a PC.
- Installation software
- Technical and maintenance instructions.



# GUYING KIT

The guying kit allows you to maintain the lightning rod, the masts as well as the pylons depending on the type of installation desired and the wind region.

It is composed of a 50 m Ø 5.6 mm fiberglass crown, 3 lantern tensioners, 6 anchor clamps, a 3-way guying collar, 3 Ø6 mm stainless steel shackles and a set of 3 expansion dowels Ø10mm.

This kit can be completed with the following accessories :

REFERENCE	AFD1050KH
Type d'installation	Lightning rod
Use	Maintenance of lightning rod and/or pylon depending on wind region
Material	Fiberglass - galvanized steel - stainless steel
Weight	< 10 kg
Standards	NF EN 62305-3 - NFC 17102

Fiberglass anchor clamp	AFD1051KU
Lantern tensioner 1 eye, 1 clevis Ø12 mm	AFD1052KU
3-way guying collar	AFD1053KU
Crown of 50 m of fiberglass Ø 5.6 mm	AFD1050KU
Double expansion anchor Ø 12 mm	AFD1062KU
Stainless steel shackle Ø 6 mm	AFD1070KU

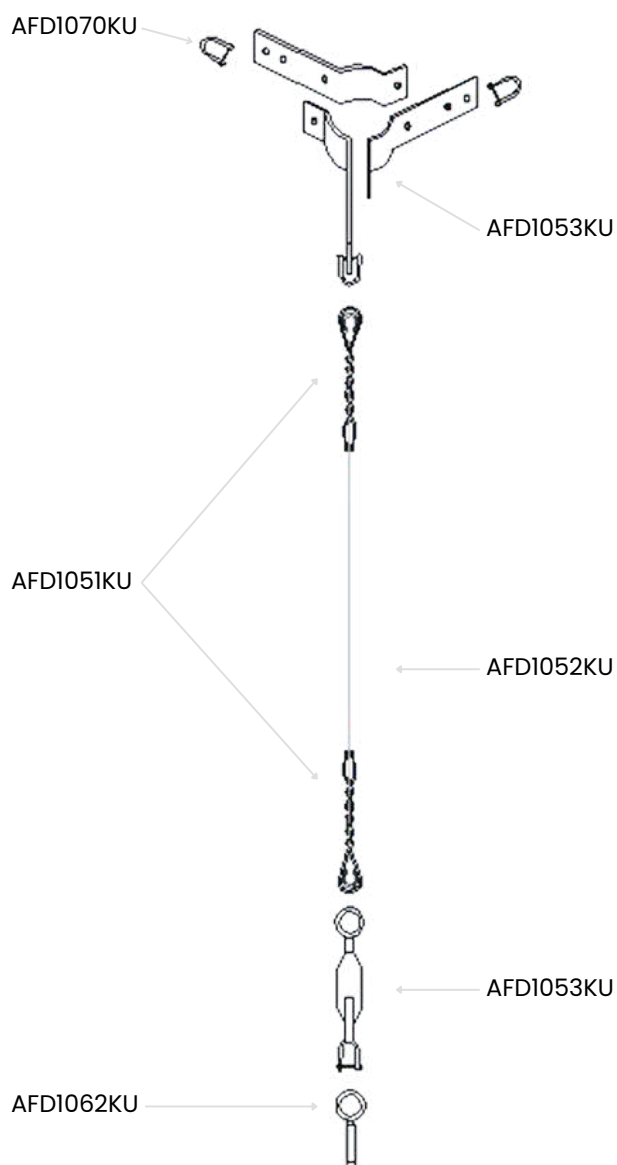

## GUYED PYLONS

The guyed pylons are made from a hot-dip galvanized metal lattice beam, with a triangular section of 175 mm center distance with round tube frames with a diameter of 22 mm.

They are delivered in sections of 3 meters. The sections will be bolted together and will be equipped with stays.

REFERENCE	Designation	Nature of sections	Weight
AFD1080KU	Guyed pylon 6 m	2 by 3 m	42,75 kg
AFD1081KU	9 m guyed pylon	3 by 3 m	52,71 kg
AFD1082KU	Guyed pylon 12 m	4 by 3 m	67,01 kg
AFD1084KU	Guyed pylon 15 m	5 by 3 m	78,67 kg
AFD1083KU	Guyed pylon 18 m	6 by 3 m	96,23 kg

## SELF-SUPPORTING PYLONS

All self-supporting pylons are equipped with a base to be sealed at the same time as the construction of the concrete base. Section connections are made using bolted plates. The height and number of sections will depend on the height of the pylon.

All elements of the pylon are made of hot-dip galvanized steel.

Choice of material according to the following parameters and sizing of the mass:

- The installation location and therefore the wind region.
- Site qualification: normal or exposed.
- The type of soil.
- The force exerted on the aerials (total force to which the pylon is subjected).

REFERENCE	Height	Charge maximum (daN)	Top surface	Recommended concrete mass C x C x H	Weight
AFC5006PA	6 m	100	0,67	1,3 x 1,3 x 1 m	77 kg
AFC5007PA	9 m	40	0,33	1,3 x 1,3 x 1 m	93 kg
AFC5009PA	9 m	100	0,63	1,4 x 1,4 x 1 m	126 kg
AFC5015PA	15 m	100	0,56	1,7 x 1,7 x 1,2 m	270 kg
AFC5018PA	18 m	100	0,96	1,7 x 1,7 x 1,2 m	296 kg
AFC5024PA	24 m	100	0,64	2,2 x 2,2 x 1,4 m	644 kg

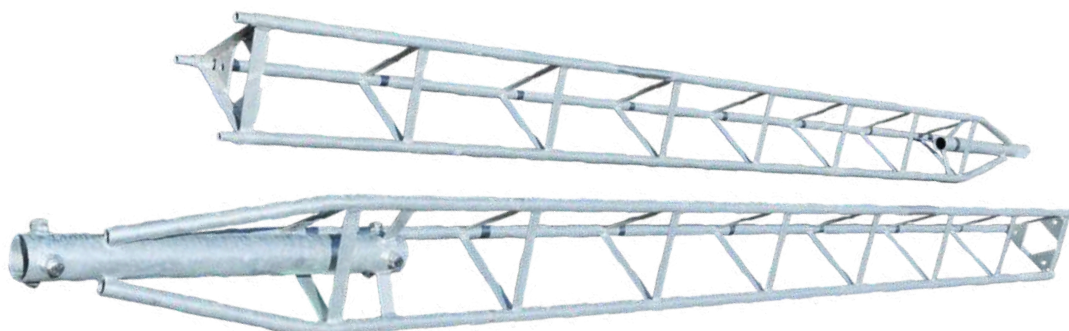

Our beacons are manufactured using LED technology. Dedicated to daytime and/or nighttime marking, they offer exceptional advantages in terms of longevity (100,000 hours), robustness and energy consumption. They can be supplied in 48V DC, 230V AC or solar version. We can also integrate a battery-backed system and redundancy with an emergency lamp. We are also able to supply a complete range of lighting equipment for heliports.

## LOW INTENSITY OBSTACLE BEACONS

Our low intensity beacons feature LED technology. Dedicated to night marking of obstacles, they offer exceptional advantages in terms of longevity (100,000 hours), robustness and energy consumption (between 2 and 5W). They can be supplied with a photocell for autonomous management of the marking and a fault report to inform in the event of a fault in the marking.



## MEDIUM INTENSITY OBSTACLE BEACONS

Our medium intensity beacons feature LED technology. Dedicated to the daytime and/or nighttime marking of obstacles, they offer exceptional advantages in terms of longevity (100,000 hours), robustness and energy consumption (between 15 and 50W average consumption). They can be supplied with a photocell for autonomous management of the marking and a fault report to inform in the event of a fault in the marking.



## MARKING FOR HIGH VOLTAGE LINES

Our range for High Voltage lines is mainly composed of two products:

- The 600mm marking sphere: dedicated to daytime marking of lines, it must be installed on the guard cable (not powered) of the line and is available in red, white, orange or two-tone version.
- The induction beacon: dedicated to nighttime marking of lines, this beacon, equipped with LED technology, works by induction and must be installed on one of the conductor cables of the power line. The system is suitable for any line voltage (1kV to 500kV) and can operate on lines ranging from 10A to 3000A.





FRANKLIN  
FRANCE

## CONTACTS

### FRANKLIN FRANCE

13 RUE LOUIS ARMAND,  
77330 OZOIR-LA-FERRIÈRE  
FRANCE

TEL : +33 (0)1 60 34 54 44

[franklin@franklin-france.com](mailto:franklin@franklin-france.com)

[contact@franklin-france.com](mailto:contact@franklin-france.com)

[WWW.FRANKLIN-FRANCE.COM](http://WWW.FRANKLIN-FRANCE.COM)



**FRANKLIN**FRANCE



Follow us now on LinkedIn so you don't miss any of the latest news and exciting projects from Franklin France!