

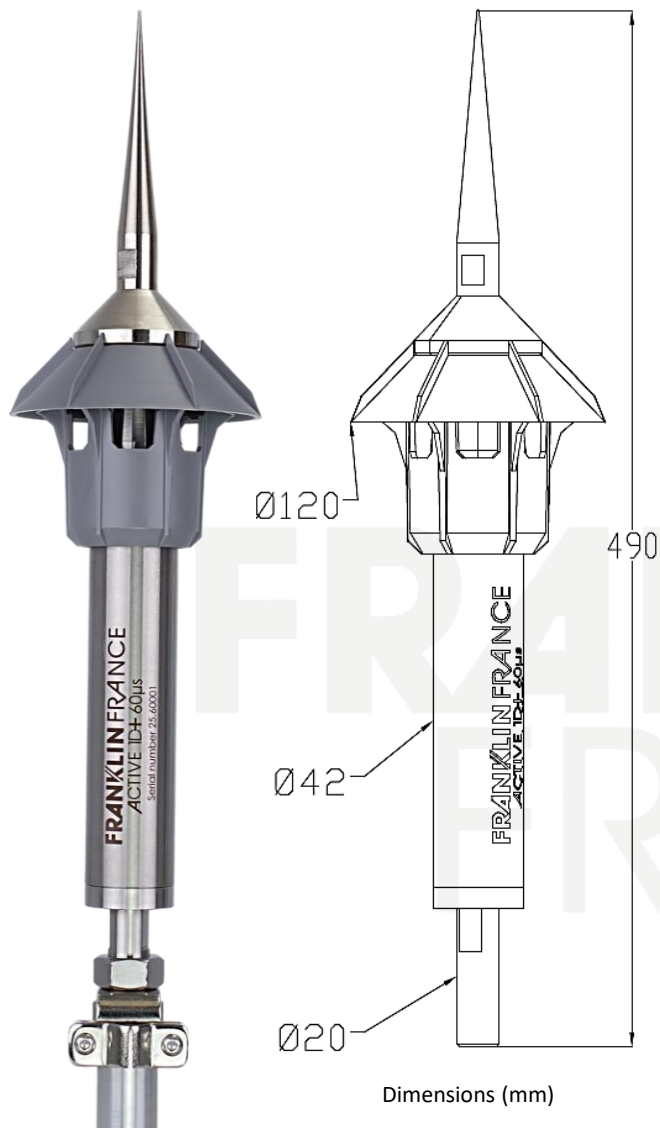

Early Streamer Emission - ESE

ACTIVE 1D+[®] 25μs



Dimensions (mm)

Functional principle

The Active 1D+ is an Early Streamer Emission (ESE) with a priming device whose operation is based on an oscillating high-voltage pulse circuit synchronized to the storm phenomenon. The resulting strong amplification of the electric field at the top of the lightning rod tip results in the anticipated emission of an upward tracer at the right moment.

Reference	AFB20251D
Technical characteristics	
Efficiency	$\Delta T = 25 \mu s$
Standard deviation σ_{ESE}	$\sigma_{ESE} = 0,43 \sigma_{SP}$ normative requirement $\sigma_{ESE} < 0,8 \sigma_{SP}$
Protection radius	According to NF C 17-102:2011 §5.2.3.2
Functional check	Dedicated tester (not included)
Exposure to weather conditions	Guaranteed insulation by means of a special deflector (tested under flow $> 56 \text{ L/min/m}^2$)
Warranty	5 years
Mechanical characteristics	
Materials	Capture tip: Nickel-plated copper Body: 304L stainless steel Deflector: Polycarbonate Internal insulation: PTFE
Extension mast attachment	M20 male thread and locknut
Connection component	Connector (EN 62561-1) for flat or round down conductor included
Net / gross weight	2,130 kg / 2,630 kg
Product certifications	
NF C 17-102 : 2011	Certificate BV n°: 24603101/3/1.2.R Compliance with test sequence on the same sample (Appendix C)
Marking tests	Laser engraving Report n°: LiRi-EMA-22112024
Environmental tests	NF EN 60068-2-52 and NF EN ISO 22479 Report LCIE n°: 24449057-806976
Electrical tests	100 kA – 10/350μs Report CITEL n°: LER-24-102-RE
Efficiency tests	Report n°: LiRi-HT-13022025
EMF tests	NF EN 61000-6-2 and -3 Report n°: XP30525433
Quality Management Certification	
ISO 9001 : 2015	AFNOR CERTIFICATION n°2022:102639.9
Qualifoudre	Certificate Ineris n°051168352016



Tested in extreme rain conditions



Option : lightning strike counter (AFV1007CF) or kit (AFD27251D)

Franklin Technologie[®] - A full range of lightning and overvoltage protection.

In the continue framework of its products, Franklin France shall be entitled to modify specifications without notice

FRANKLIN FRANCE

FT148EN.QLF.00

13, rue Louis Armand - 77330 Ozoir-la-Ferrière / +33 (0)1 60 34 54 44

contact@franklin-france.com / www.franklin-france.com

SA à conseil d'administration au capital de 1 799 200 € - SIRET n°31974708500045 - APE 4669A - TVA FR22319747085

