

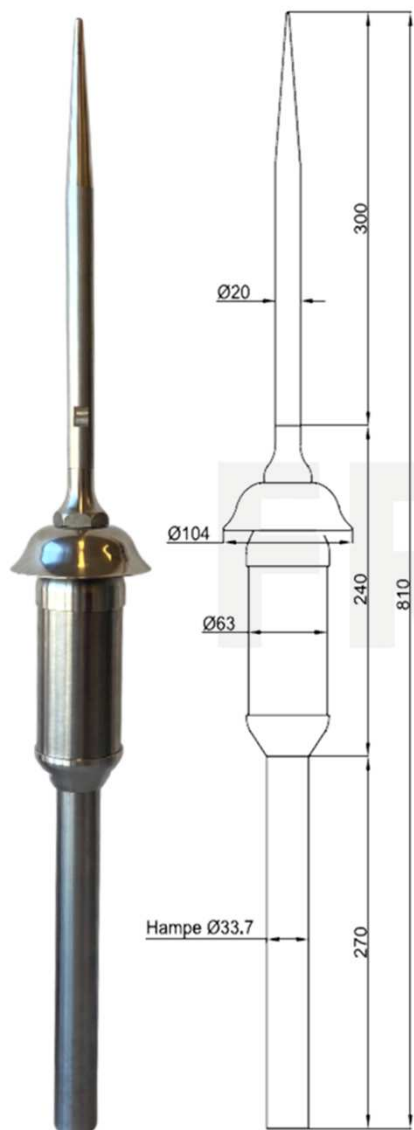

# Lightning products

## Early Streamer Emission (ESE)

### ACTIVE 1D®25



Dimensions (mm)

### Principle and operation

The excitation advance of the Active 1D® is obtained by a device called an “impulse device”. Its principle consists of storing the electrostatic energy present in the atmosphere as a storm cloud approaches and then triggering the initiation of the upward discharge at the appropriate time.

This device is operated by an integrated sensor measuring the value of the ambient electric field.

It then causes an almost instantaneous reversal of the polarity of the head of the lightning rod, leading to an amplification of the electric field on its tip.

### Technical data

<b>Excitation advance</b>	$\Delta T$ 25 $\mu s$
<b>OPDA standard deviation</b>	$< 0,8 \sigma_{PTS}$
<b>Shock current resistance 10/350<math>\mu s</math></b>	100 kA
<b>Material</b>	Stainless steel 304L
<b>Protection radius</b>	According to NF C 17-102:2011
<b>Checking correct operation</b>	Dedicated tester (not included)
<b>Warranty</b>	24 months
<b>Reference</b>	<b>AFB10251D</b>
<b>Fixation</b>	Shaft $\varnothing 33.7$ mm (included)
<b>Weight</b>	3,6 kg
<b>Accessories included</b>	Conductive connecting collar
<b>Certifications</b>	
<b>Standards</b>	Compliant with NF C 17-102:2011, appendix C
<b>Qualifoudre</b>	Ineris certificate n°051168352016
<b>ISO 9001 : 2015</b>	AFNOR CERTIFICATION n°2022:102639.9



AFV1007CF lightning strike counter (included with kit)

### Lightning Rod Kit + Counter

Ref AFB17251D = Active 1D (AFB10251D) + Counter (AFV1007CF)

Franklin Technologie® - A full range of lightning and overvoltage protection.

In the continue framework of its products, Franklin France shall be entitled to modify specifications without notice

**FRANKLIN FRANCE**

FT121EN.QLF.00